

INSTALLATION MANUAL

GAS WATER HEATER WHi49 , LWHi49 (Internal)

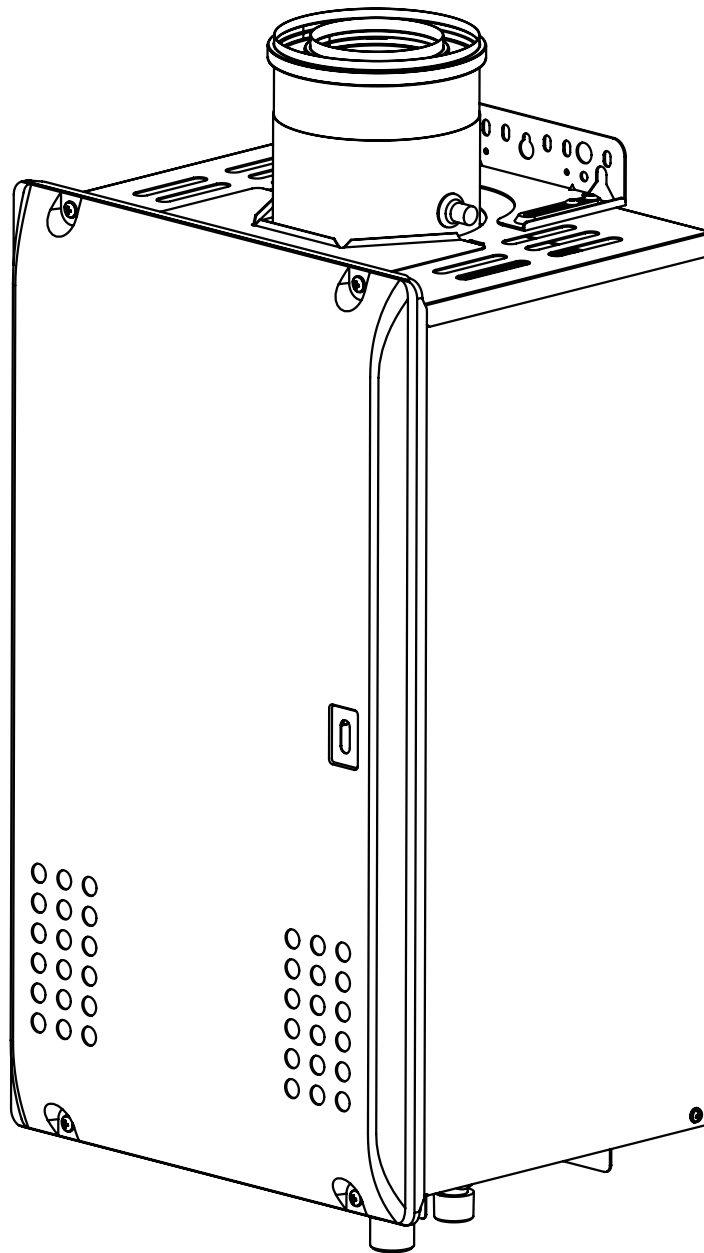

SBB80ZD

Please read and understand these instructions before commencing installation and leave this manual with the customer for future reference.

Andrews. Built to perform.



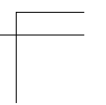
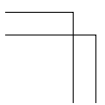
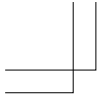

Installation Manual

CONDENSING GAS WATER HEATER



WHi49, LWHi49 (Internal)

AGENT :
ANDREWS WATER HEATERS
Innovation House 3 Oaklands
Business Centre Oaklands Park
Wokingham Berkshire RG41 2FD, UK

PRODUCT :
NORITZ CORPORATION
5, Minamifutami, Futami-cho,
Akashi, Hyogo, Japan

WARNING: If the information in this manual is not followed exactly, a fire or explosion may result causing property damage, personal injury or death.

Potential dangers from accidents during installation and use are divided into the following three categories. Closely observe these warnings, they are critical to your safety.

 Danger	Danger of serious injury or even death as well as danger of fire when the product is misused by ignoring this symbol.
 Warning	Possibility of serious injury or even death as well as possibility of fire when the product is misused by ignoring this symbol.
 Caution	Possibility of bodily injury or damage to property when the product is misused by ignoring this symbol.



Prohibited



Disconnect
Power



Earth



Be sure to do

Requests to Installers



Caution



- In order to use the water heater safely, read this installation manual carefully, and follow the installation instructions.

- Failures and damage caused by erroneous work or work not as instructed in this manual are not covered by the warranty.
- Check that the installation was done properly in accordance with this Installation Manual upon completion.
- After completion of installation, be sure to hand the Operation Manual to the customer upon filling in all of the required items.

- The appliance must be installed in accordance with the Gas Safety (Installation and Use) Regulations and the rules in force in the country of installation.
- The manufacturer's instructions supplied.
- The Gas Safety (Installation and Use) Regulations.
- The appropriate Buildings Regulations either The Building Regulations, The Building Regulations (Scotland), The Building Regulations (Northern Ireland).
- In IE, the installation must be carried out by a competent person and installed in accordance with the current edition of I.S.813 "Domestic Gas Installations", the current Building Regulations and reference should be made to the current ETCI rules for Electrical Installation.







1. Included Accessories

The following accessories are included with the unit. Check for any missing items before starting installation.

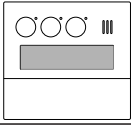
Part	Shape	Q'ty	Part	Shape	Q'ty
Owner's Guide		1	Installation Manual (this document)		1
Tapping Screw		5			

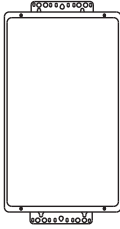
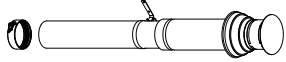
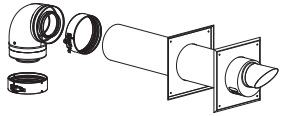
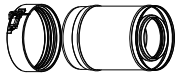
2. Optional Accessories

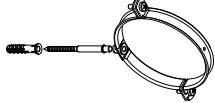
The accessories listed below are not included with the units, but may be necessary for installation.

Part	Shape	Q'ty	Part	Shape	Q'ty
Main Controller (RC-9018C)		1	Quick Connect Cord-2 (2m)		1
System Controller (SCU-401-12M) for 1-6 units		1	Roof Terminal		1
			Wall Terminal		1
Extension (With locking band)		1	Elbow 90° (With locking band)		1
Elbow 45° (With locking band)		1	Wall Bracket		1
Air intake grill 80/125mm (Female)		1			

Item	Specification	
Model Name	WHi49	LWHi49
Flue Type	C ₁₃ , C ₃₃ , B ₂₃	
Category	II _{2H 3P}	
Electrical Consumption	75.9W	81.0W
Freeze Preventive Heater	193W	193W
Gas Supply Pressure	G20 20mbar	G31 30/37mbar
Max.Burner Setting Pressure	6.7mbar	7.8mbar
Min.Burner Setting Pressure	3.1mbar	3.6mbar
Max.Water Pressure	10.0bar	10.0bar
Min.Water Pressure	1.0bar	1.0bar
Max.Heat Output (CONDENSING)	49kW	49kW
Min.Heat Output (CONDENSING)	3.6kW	3.6kW
Max.Heat Input(NET)	53.5kW	53.5kW
Min.Heat Input(NET)	4.35kW	4.35kW
Destination Countries	GB&IE	GB&IE
IP Rate	IP20D	

3. Quick Connect Multi System Installation

- The Quick Connect Multi System allows the installation of two units together utilizing only the Quick Connect Cord-2.

The Quick Connect Cord-2 is 2m long. Install the units 50 - 457mm apart from each other to ensure the cord will be able to reach between the units. (See Typical Plumbing diagram). (If the distance between the two units is too great, not only will the cord not be able to reach, but the water temperature may also become unstable because of the difference in pipe length between the two units).

System Diagram

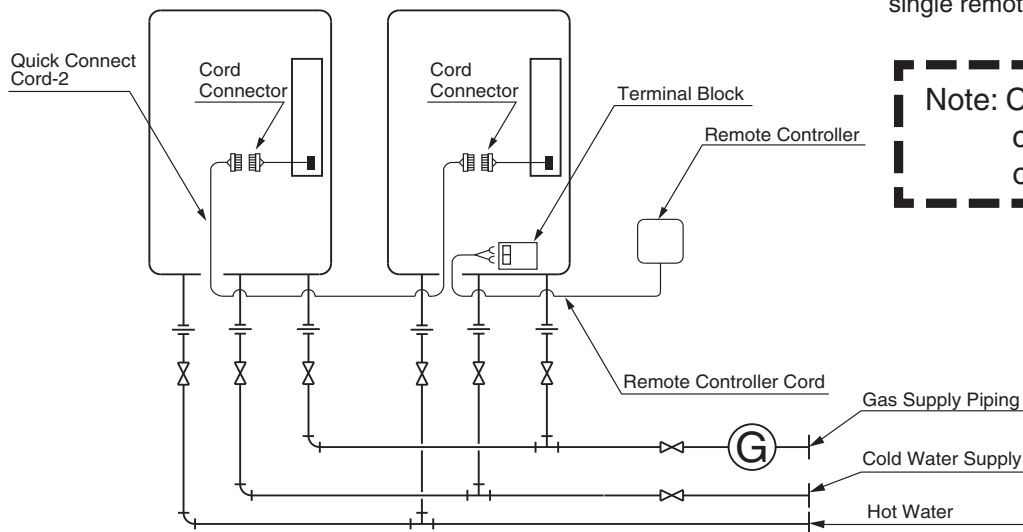

* When connecting 2 devices, use only a single remote controller.

Note: Connect the remote controller to only one of the devices.

Typical Plumbing

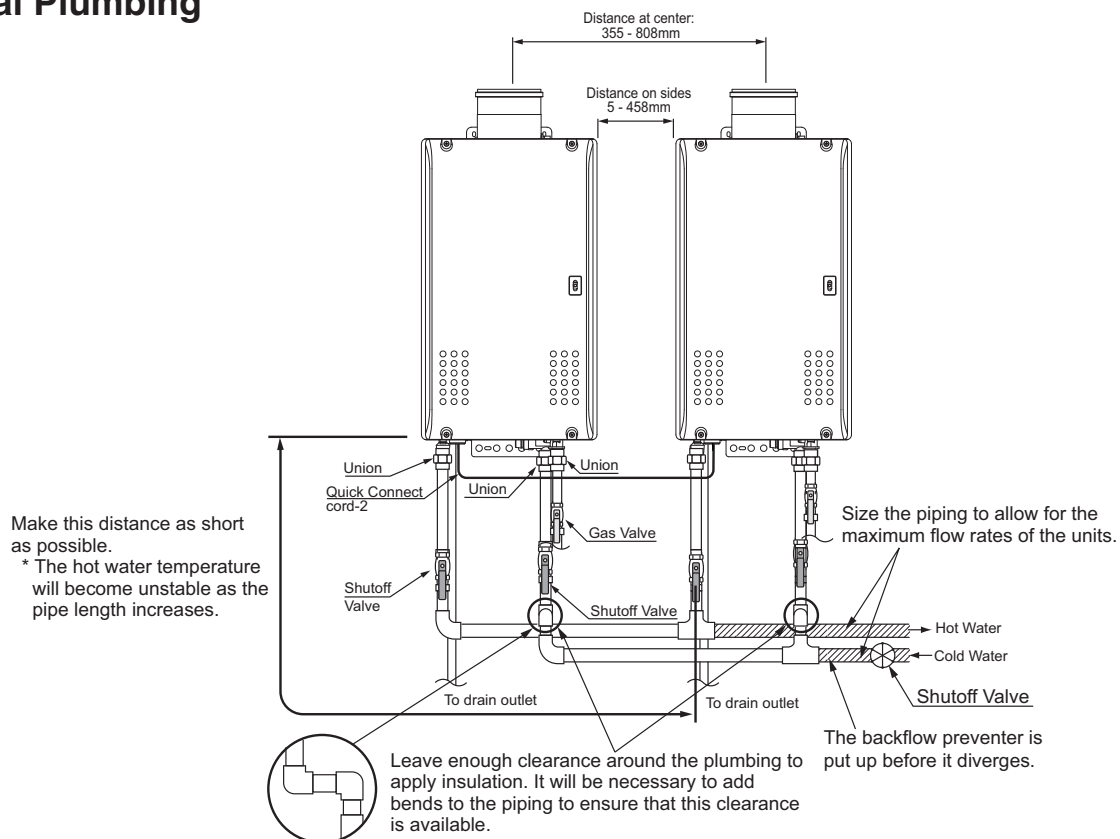

- Insulate the hot water piping to prevent heat loss. Insulate and apply heating materials to the cold water supply piping to prevent heat loss and freezing of pipes when exposed to excessively cold temperatures.

4. Before Installation

Warning

Precautions on replacement of equipment

- Replace the intake and exhaust pipe, the flue terminal and the fixing bracket with new one as a general rule. However, the material of intake and exhaust pipe, flue terminal or fixing bracket is equivalent to SUS304 or more, these parts can be reused.
- * Check there is no hole, crack, block on the intake and exhaust pipe and misalignment of connection part and there is no problem before using these parts.
- * Replace the flue terminal with the product specified by our company.

Confirmation of top of adapted flue terminal

- Use the flue terminal specified by our company, which is described in this construction manual. If it is mismatching, it will cause a fire or other accident.

Precautions on accumulation of snow or fallen snow

- If an accumulation of snow is forecasted, undertake the construction of flue terminal so that it is not blocked by surrounding accumulation of snow or fallen snow.

Caution

Check the Gas

- Check that the rating plate indicates the correct type of gas. If the equipment is used with a gas other than displayed one, it will cause an explosion or a fire. Check that the gas supply line is sized for 54.0 kW for this unit.

Check the Power

- The power supply required is 220 - 240V AC, at 50Hz. Using the incorrect voltage may result in fire or electric shock.

Do Not Use Equipment for Purposes Other Than Those Specified

- Do not use for purposes other than increasing the temperature of the water supply, it will cause an unexpected accident or a failure of equipment.

Check Water Supply Quality

- If the water supply is hard, acidic or otherwise impure, treat the water with approved methods in order to ensure full warranty coverage.

Do not use hot spring water, well water or under ground water.

- The foreign material is attached to the piping in the equipment or the piping become eroded and causes water leakage depending on the quality of water. In this case, the repair will be implemented with charge even within the guarantee period.

Use Extreme Caution if Using With A Solar Pre-Heater

- Using this unit with a solar pre-heater can lead to unpredictable output temperatures and possibly scalding. If absolutely necessary, use mixing valves to ensure output temperatures do not get to scalding levels. Do not use a solar pre-heater with the quick-connect multi-system.

Checkup

- Check the fixing brackets and the flue pipe yearly for damage or wear. Replace if necessary.

5. Choosing Installation Site

The appliance must be installed in a suitably ventilated room, in accordance with the regulations in force.

- * Locate the appliance in an area where leakage from the unit or connections will not result in damage to the area adjacent to the appliance or to the lower floors of the structure. When such locations cannot be avoided, it is recommended that a suitable drain pan, adequately drained, be installed under the appliance. The pan must not restrict combustion air flow.

Danger

- Do not install the fence or the obstacle around the flue terminal. It will cause carbon monoxide poisoning.

Warning

- The water heater is designed for internal installation only. Never install it outdoors or in a bathroom, it may be damaged or a fire may be caused.

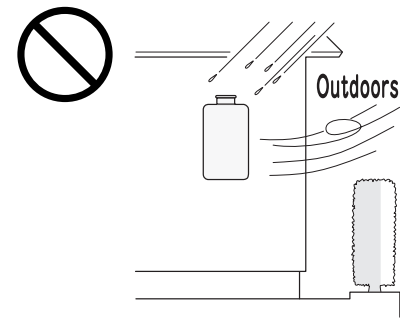

Caution

- Consult with the customer concerning the location of installation.
- Avoid places where fires are common, such as those where petrol, benzene and adhesives are handled, or places in which corrosive gases (ammonia, chlorine, sulfur, ethylene compounds, acids) are present.
This may cause incomplete combustion or failures.
- Locate the flue terminal so that there are no obstacles around the termination and so that exhaust can't accumulate. Do not enclose the termination with corrugated metal or other materials.
- Install the water heater in an area that allows for the proper clearances to combustible and noncombustible construction.
- Do not install the water heater in a place where it may be threatened by falling objects, such as under shelves.
- The water heater must be installed in a place where supply and exhaust pipes can be installed as directed.

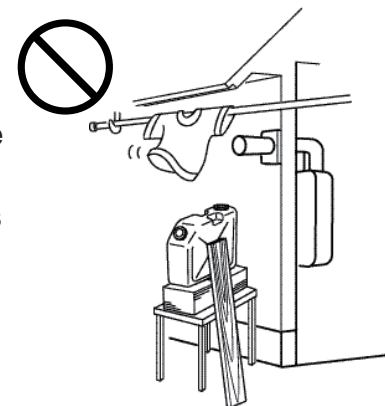

- Do not install the water heater where the exhaust will blow on outer walls or material not resistant to heat. Also consider the surrounding trees and animals.

The heat and moisture from the water heater may cause discoloration of walls and resinous materials, or corrosion of aluminum materials. As the heatproof temperature of wired sheet glass is approximately half of that of general glass and it is breakable, the glass may break because of exhaust gas if there is wired sheet glass in the exhaust direction of equipment (approximately 1m or less). Be sure to avoid the installation or change the exhaust direction.

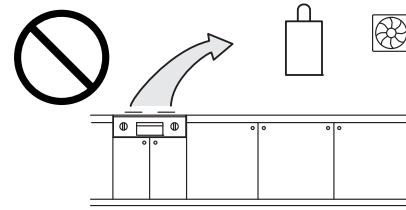

- Avoid installation above gas ranges or stoves.
- Avoid installation between the kitchen fan and stove. If oily fumes or a large amount of steam are present in the installation location, take measures to prevent the fumes and steam from entering in the equipment.
- Avoid installation in places where dust or debris will accumulate. Dust may causing the performance of the fan motor to drop and incomplete combustion to occur as a result.
- Install in a location where the exhaust gas flow will not be affected by fans or range hoods.
- Take care that noise and exhaust gas will not affect neighbors.
- Avoid installation in places where special chemical agents (e.g., hair spray or spray detergent) are used. Ignition failures and malfunction may occur as a result.
- When you install the equipment, check the wall or ceiling around the installation place is safe for fire protection or install the equipment where the free space effective for fire protection can be ensured.

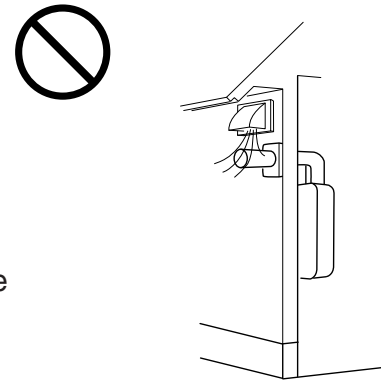
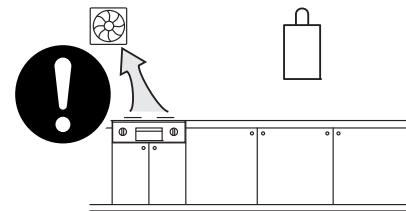

6. Installation Clearances

Before installing, check for the following:

The appliance must be installed in a suitably ventilated room, in accordance with the regulations in force.
 Install in accordance with relevant building and mechanical codes, as well as any local, state or national regulations.

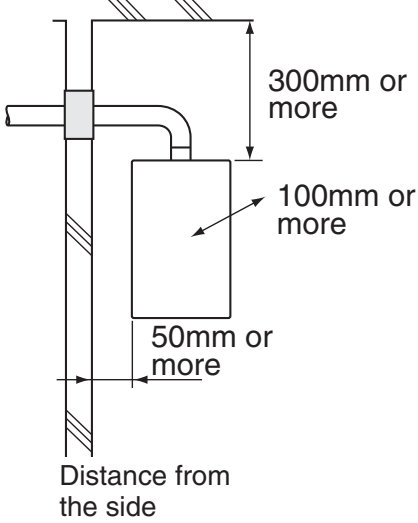
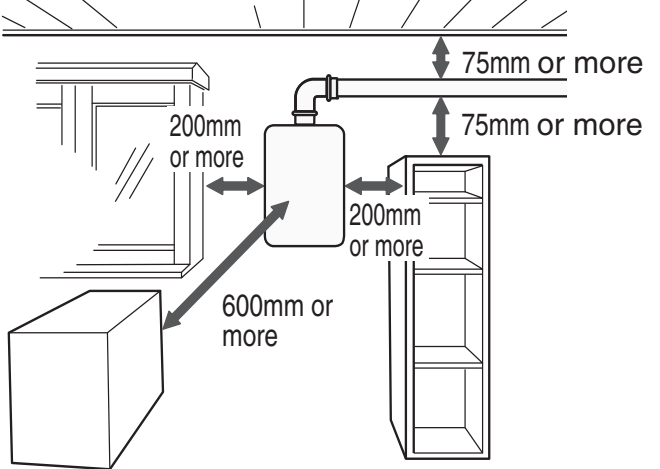
Item	Check	Illustration
Distance from combustibles	<ul style="list-style-type: none"> Maintain the following clearances from both combustible and non-combustible materials. 	
Securing of space for repair/inspection	<p>In order to facilitate inspection and repair it is recommended to leave:</p> <ul style="list-style-type: none"> 200mm or more on either side of the unit. 600mm or more in front of the unit. 75mm or more above and below the vent pipe. 	

FLUE REQUIREMENTS

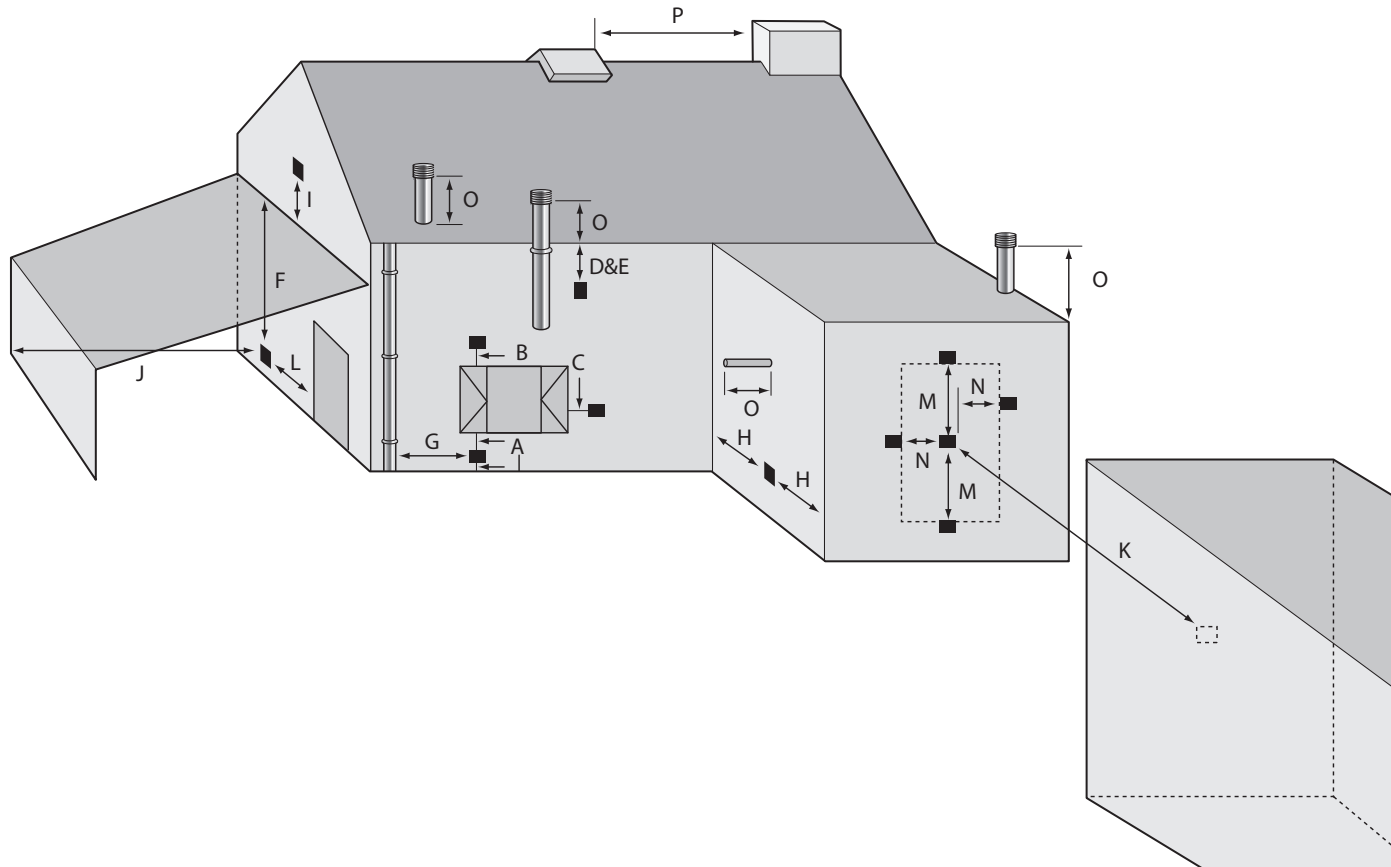

Symbol	Terminal Position	Dimension
A	Directly below an opening, air brick, opening windows, ect.	300mm
B	Above an opening, air brick, opening window, ect.	300mm
C	Horizontally to an opening, air brick, opening window, ect.	300mm
D	Below plastic gutters, soil pipes, drain pipes, ect.	75mm
E	Below eaves	200mm
F	Below balconies or car port roof	200mm
G	From vertical drain pipe or soil pipe	150mm
H	From and internal or external corner	300mm
I	Above ground, roof or balcony level	300mm
J	From surface facing the terminal	600mm
K	From terminal facing terminal	1200mm
L	From opening in the car port (eg door, window ect) into the dwelling	1200mm
M	Vertically from terminal on the same wall	1500mm
N	Horizontally from terminal on the same wall	300mm
O	From the wall on which the terminal is mounted	0
P	From a vertical structure on the roof	N/A
Q	Above intersection with the roof	300mm

7. Installation

Securing to the wall



- The weight of the device will be applied to the wall. If the strength of the wall is not sufficient, reinforcement must be done to prevent the transfer of vibration.
- Do not drop or apply unnecessary force to the device when installing. Internal parts may be damaged and may become highly dangerous.
- Install the unit on a vertical wall and ensure that it is level.

Item	Check	Illustration																
Locating Screw Holes	<div style="border: 1px solid black; padding: 5px; text-align: center;"> Caution </div> <ul style="list-style-type: none"> • When installing with bare hands, take caution to not inflict injury. • Be careful not to hit electrical wiring, gas, or water piping while drilling holes. <ul style="list-style-type: none"> • The distance between the unit and the wall can be adjusted within the range of 10 - 46mm. Adjust the brackets as necessary to accommodate the vent system (factory default is 10mm). <ol style="list-style-type: none"> 1. Loosen the four screws in the mounting bracket (upper), match the desired mark to the back of the unit, and then tighten the screws. 2. Loosen the four screws in the mounting bracket (lower) and secure it in the same position as the upper mounting bracket. 3. Drill a single screw hole, making sure to hit a stud. 4. Insert and tighten the screw and hang the unit by the upper wall mounting bracket. 5. Determine the positions for the remaining four screws (two for the top bracket and two for the bottom), and remove the unit. 																	
Mounting	<ol style="list-style-type: none"> 6. Drill holes for the remaining four screws. 7. Hang the unit again by the first screw, and then insert and tighten the remaining four screws. 8. Take waterproofing measures so that water does not enter the building from screws mounting the device. 																	
Structure	<ul style="list-style-type: none"> • Make sure the unit is installed securely so that it will not fall or move due to vibrations or earthquakes. 																	
Installations at Elevations Above 610m.	<ul style="list-style-type: none"> • Adjust the dip switches as illustrated in the table to the right if this water heater is installed at an altitude of 610m or higher. • Disconnect power to the water heater before changing the dip switches. Failure to perform this step will result in a "73" code displayed on the operation panel and a cease in operation. If this occurs, disconnect, then reconnect power to the water heater to reset the system. <p>Note : Please refer to page 14 for the location of the dip switch bank.</p>	<p>* Do not change any other dipswitches.</p> <div style="display: flex; align-items: center;"> <div style="margin-right: 20px;"> <p>OFF </p> <p>ON </p> </div> <div style="margin-right: 20px;"> <p>* High elevation adjustment.</p> <table border="1" style="border-collapse: collapse; text-align: center;"> <tr> <td style="width: 20px;">1</td> <td style="width: 20px;">1</td> </tr> <tr> <td>2</td> <td>○</td> </tr> <tr> <td>3</td> <td>○</td> </tr> <tr> <td>4</td> <td>○</td> </tr> <tr> <td>5</td> <td>○</td> </tr> <tr> <td>6</td> <td>○</td> </tr> <tr> <td>7</td> <td>○</td> </tr> <tr> <td>8</td> <td>○</td> </tr> </table> </div> <div> <p></p> </div> </div> <p>ON=● OFF=○</p>	1	1	2	○	3	○	4	○	5	○	6	○	7	○	8	○
1	1																	
2	○																	
3	○																	
4	○																	
5	○																	
6	○																	
7	○																	
8	○																	

8. Flue Pipe Installation

Flue Terminal Installation

- Follow the installation instructions included with the flue terminal and which are reproduced at the end of this manual. This appliance must be the flue through the wall, not vertically to the roof.

Flue Terminal Installation Precautions

Note the following flue terminal installation requirements

- Do not install the flue terminal indoors

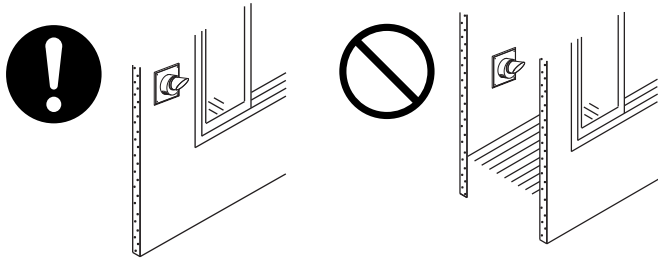

- Install the flue terminal with a downward slope

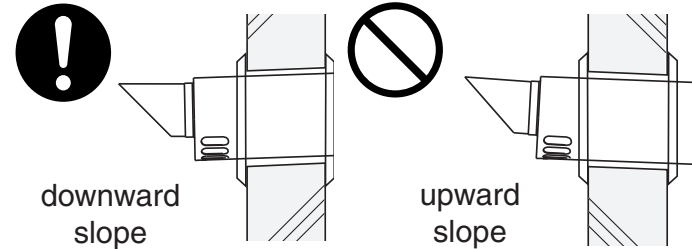

- Avoid storing hazardous objects near the terminal

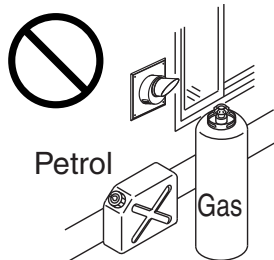

- Avoid installing the terminal where obstacles will block it

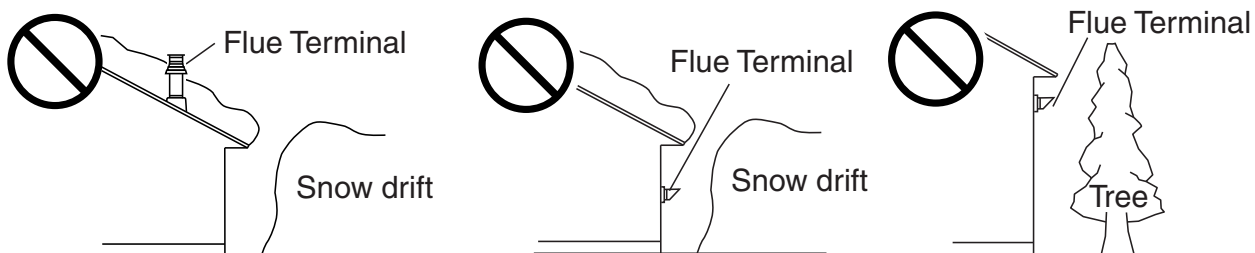

- In the case the discharge direction of the exhaust is to the side as shown in the diagram below, do not select the supply/exhaust tube top. Incomplete combustion caused by short cycling of exhaust gas may occur as a result. (except terminal guard.)

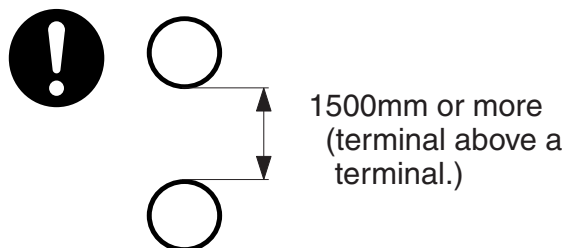

- Clearance from the flue terminal. If multiple units are installed, terminals must be separated by 300mm or more in a plain view regardless of the vertical clearance.

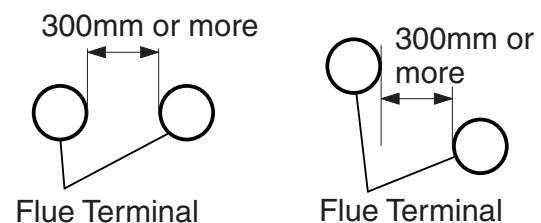

Detailed recommendations for the flue installations are given in BS 5440:1:2000. The following notes are for general guidance only.

Note: An adapter is always required on top of the heater.

For the vertical flue set up, offset adapter will be supplied for the air intake.

- a) The flue system must be constructed using only Andrews Water Heaters approved components.
- b) It is important that the position of the terminal allows free passage of air across it at all times.
- c) It is **ESSENTIAL TO ENSURE** that products of combustion discharging from the terminal cannot reenter the building, or any other adjacent building, through ventilators, windows, doors, other sources of natural air infiltration, or forced ventilation / air conditioning.
- d) The minimum acceptable dimensions from the flue terminal to obstructions and ventilation openings are specified in the regulations.
- e) If the flue terminal discharges into a pathway or passageway check that combustion products will not cause nuisance and that the terminal will not obstruct the passageway.

Assembling Air/Flue Pipes

The flue pipes must be assembled with the plain end of pipe or fitting nearest the boiler and the female (socket) end furthest from the boiler. Check that a seal is fitted in every socket.

Always adjust length of pipes by cutting and de-burring plain end so that it does not damage or disturb the seal. Remove burrs from inside and outside of pipe and ensure the pipe is clean and free from oil and grease.

- a. Measure and cut the first pair of the flue pipes away from the appliance. Push pipes fully into the sockets on top of the boiler whilst also fitting the flue duct prepared as above.
- b. Measure and cut next pair of the air/flue pipes.
- c. Prepare pipe support brackets as required before engaging pipes with the socket of preceding pipes or bends.
- d. Push pipes together as before taking care not to dislodge seals. When cutting and fitting the flue pipes on extended the flue systems, allow approx. 5 mm clearance at the bottom of each joint.
- e. Repeat above procedure to reach terminal. Ensure that air inlet and the flue gas connections are correctly made and are not inadvertently reversed.
- f. Fix pipe supports to masonry or woodwork so that the flue/air pipes are held securely in position.
- g. Check especially that all joints within any duct or other void are correctly engaged and sealed before fixing the ductwork.

Installing Horizontal Extended Terminal

Important: The flue terminal must be installed horizontally.

1. Mark the centre of the 152mm diameter hole and core drill.

Note: If the wall is clad with a combustible material an additional 25mm wide area must be removed around liner.

2. Measure the wall thickness and cut the liner to this length.

Note: Cut opposite end to rim and allow some material to be used as tabs on the inside of the wall to ensure a secure fixing.

Note: If the terminal has to be fitted from inside the property, the liner can be inserted with the rim on the inside.

3. Fit the liner through the hole and make good internal and external rendering.
The latter may be done with arm extended through liner.

4. Push the flue terminal assembly into liner. Ensure terminal protrudes by 110mm from the wall.

Important: The grille must be totally exposed to air. Fit the closure plate around the pipes and secure to the wall.

5. The flue pipe **MUST** be supported by a pipe clamp before the first joint.

Note: The flue pipe ends with a female socket designed for use with the optional 3° Bend.
If not using the bend, the socket should be cut off the flue pipe.

Maximum Flue Length Adjustment DIP switches

The unit can be adjusted to accommodate longer flue runs; refer to the below table to find the maximum flue length based on the number of elbows. Adjust the DIP switches according to the flue condition noted in the tables below.

Note: By default, the unit has been set to the "① minimum length" condition.

- Disconnect power to the water heater before changing the DIP switches. Failure to perform this step will result in a "73" code displayed on the remote controller and a cease in operation. If this occurs, disconnect, then reconnect power to the water heater to reset the system.

[Maximum flue Length Example]

- One 90° elbows, maximum length = 1 m
(with DIP switches set at "minimum length" condition)
- Two 90° elbows, maximum length = 9 m
(with DIP switches set at "maximum length" condition)

<Maximum Flue Length Configurations>

Type : C₁₃, C₃₃

Flue length*	Elbows				
	0	1	2	3	4
1	① Minimum length				
2		② Short length			
3			③ Long length		
4				④ Maximum length	
5					
6					
7					
8					
9					
10					
11					
12					
13					

* Not including the flue terminal.

Type : B₂₃

Flue length*	Elbows				
	0	1	2	3	4
0					
1	① Short length				
2		② Long length			
3					
4					
5					
6					
7					
8					
9					
10					
11					
12					
13					

* Not including the flue terminal.

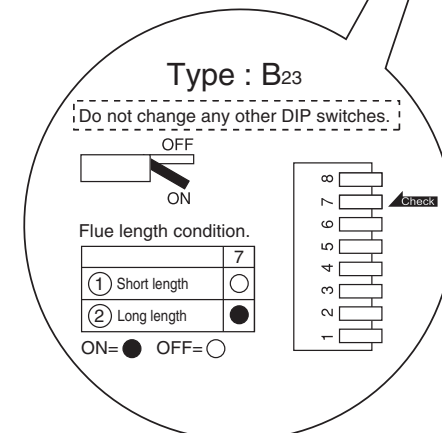
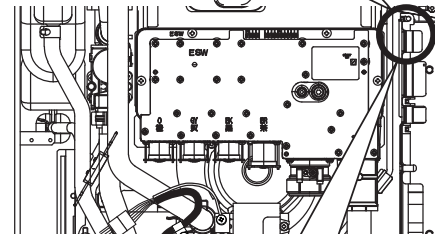
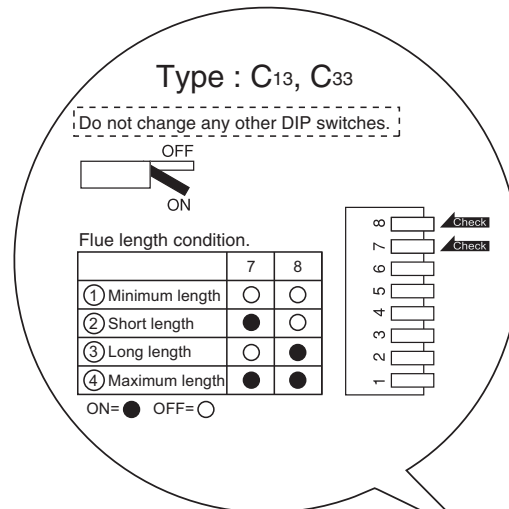

 The power must be unplugged when adjusting the DIP switches to switch the airflow amount.

- Exceeding the maximum flue length is dangerous and may result in bad combustion.
 - Install the flue terminal so that all exhaust is directed to and all intake air is taken from outdoors.
 - Do not store hazardous or flammable substances near the flue terminal.
 - Slope the flue pipe 50mm for every 1m either towards the horizontal termination or towards the integrated condensate collector.
- When using the condensate collector, create a trap in the drain line and pre-charge it with water to prevent exhaust gas leakage.
- Maintain the same flue pipe diameter all the way to the end.
 - Use only Andrews Water Heaters specified flueing products.
 - Connect the flue pipe firmly so that it will prevent exhaust gases from leaking.
- Steam or condensed water may drip out of the flue terminal. Dispose of this condensed water according to local codes and in order to prevent injury or property damage.
 - If this product will be installed in an area where snow is known to accumulate, protect the flue termination from blockage by snow drifts or damage from snow falling off of roofs.
 - Support the flue pipe with hangers at a minimum of every 2m.
 - Make the vertical pipe as short as possible.
 - Do not common flue or connect more than one appliance to this flueing system.
 - Terminate at least 300mm above grade or snow line.
 - Terminate at least 2.3m above a public walkway.

⚠ WARNING



Be sure to do

CARBON MONOXIDE POISONING

Do not remove the cap from the condensate collector unless it is being used to drain condensate. Without the cap in place, flue products could enter the living space.

Horizontal Flue Termination

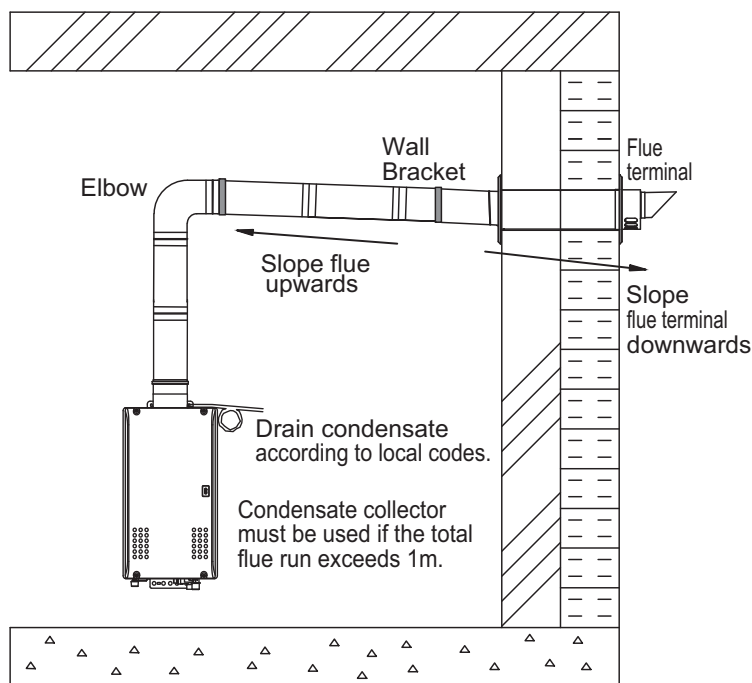

- Terminate at least 350mm above ground.
- Terminate at least 2.3m above a public walkway, 2m from the combustion air intake of any appliance, and 1m from any other building opening, gas utility meter, service regulator etc.
- Terminate at least 1m above any forced air inlet, 1.5m below, 500mm horizontally from and 300mm above any door, window, or gravity air inlet into any building as per BS5440.
- Slope the horizontal flue 50mm upwards for every 1m.
- Flue terminal must either be the outside (max. 10 mm per meter).
- Use a condensation drain if necessary.
- The integrated condensate collector must be used for total flue runs in excess of 1m. Remove the cap from the collector prior to attaching the drain line.

Vertical Flue Termination

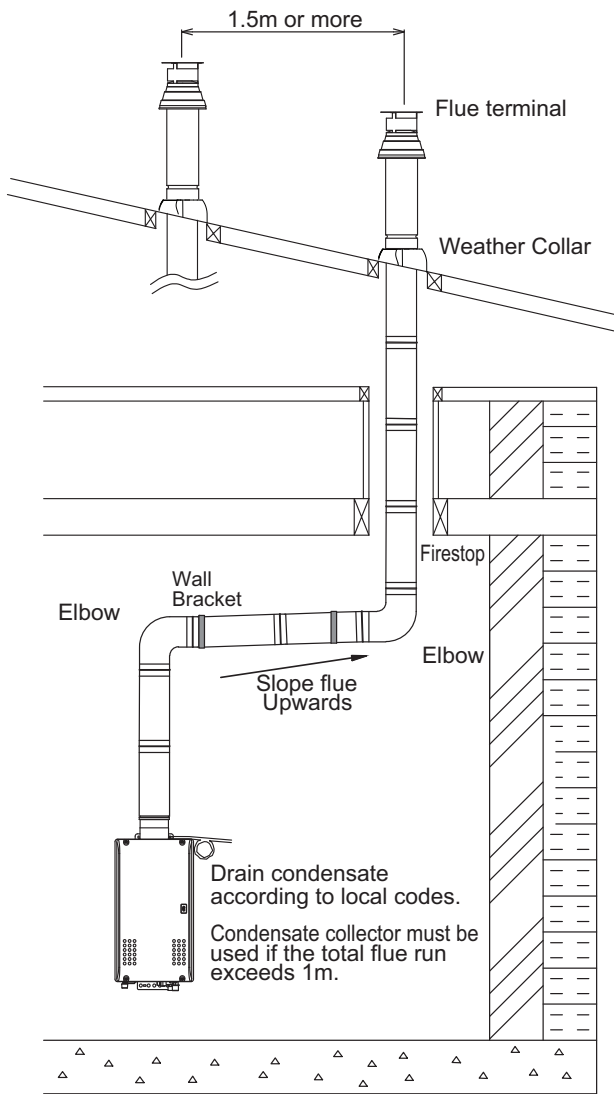

- Terminate at least 1.8m from the combustion air intake of any appliance, and 1m from any other building opening, gas utility meter, service regulator etc.
- Terminate the flue system under 600mm above the roof line, or according to the flue pipe manufacturer's instructions.
- Provide vertical support every 3.6m or as required by the flue pipe manufacturer's instructions.
- Slope the horizontal flue 50mm upwards for every 1m.
- The integrated condensate collector must be used for total flue runs in excess of 1m. Remove the cap prior to attaching the drain tubing.
- When 2 units are installed in a Quick Connect Multi System, maintain a minimum distance of 1.5m between the vertical terminations.

When the flue pipe passes through an enclosed space:

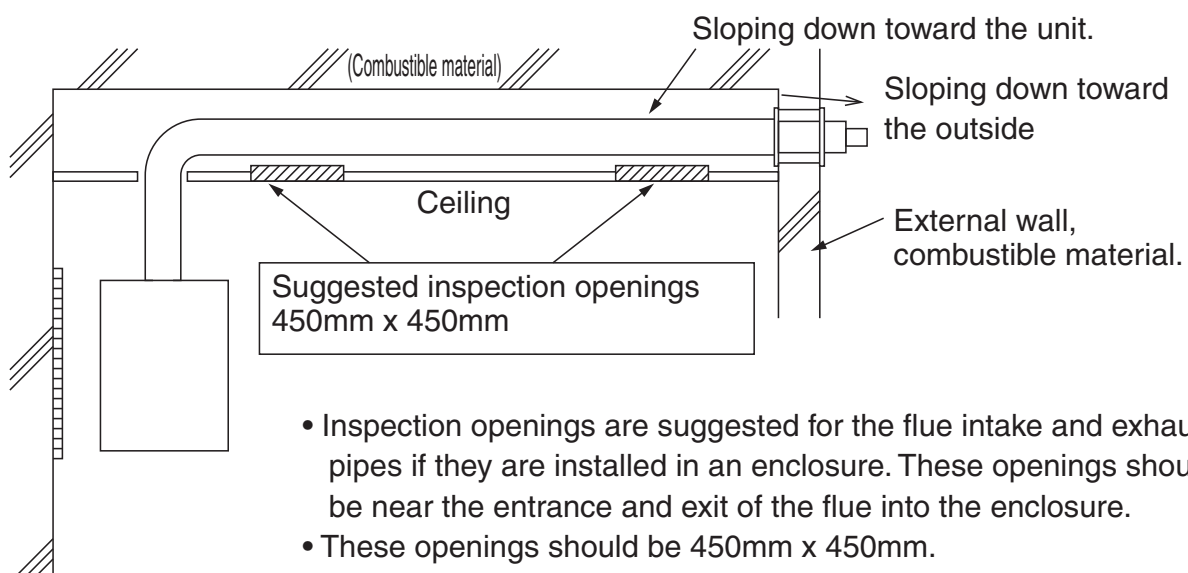

- Inspection openings are suggested for the flue intake and exhaust pipes if they are installed in an enclosure. These openings should be near the entrance and exit of the flue into the enclosure.
- These openings should be 450mm x 450mm.

Type : C₁₃, C₃₃
(HORIZONTAL / VERTICAL FLUE TERMINAL)

Flue system installation example

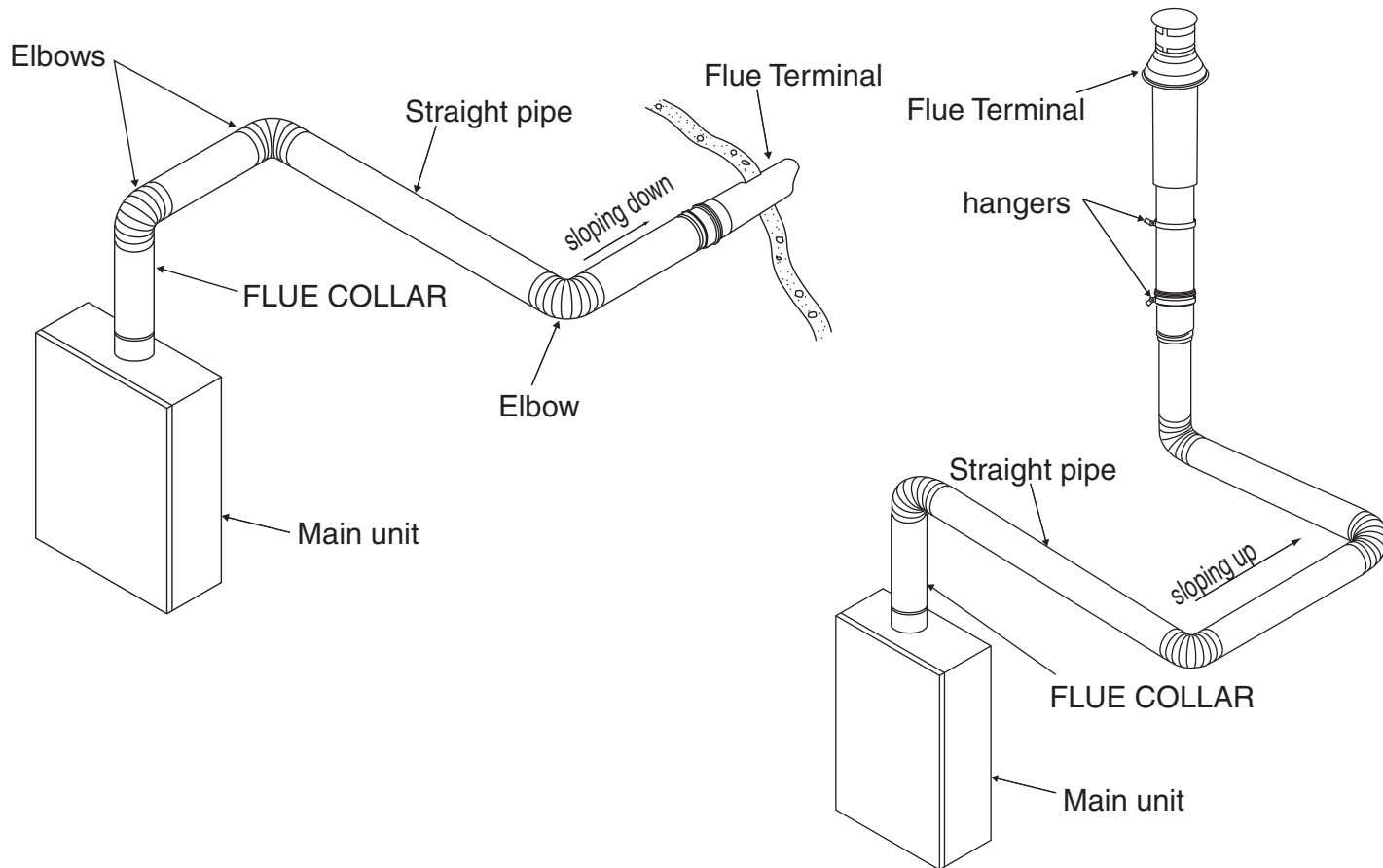

Flue Precautions

- Use 100mm diameter exhaust pipe.
- Maximum flue length
 4 elbow (90 degree) +
 5 m (exhaust pipe) + Flue Terminal
 *Maximum flue length : 13m
- Minimum flue length
 1 elbow (90 degree) + Flue Terminal
- Exceeding the maximum flue length is dangerous and may result in bad combustion.
- Maximum 90 degree bends not to exceed 4.
- Maximum length must be reduced by 2000mm for each 90° bend used.
- Maximum length must be reduced by 1000mm for each 45° bend used.
- If possible, don't install the flue pipe through any enclosed areas. If necessary, consult ANDREWS WATER HEATER for clearances.
- Install the flue terminal so that all exhaust is directed to and all intake air is taken from outdoors.

- Do not store hazardous or flammable substances near the flue terminal.
- Slope the intake and exhaust pipes at a 1/20 grade up towards the termination.
- Connect the flue pipe firmly so that it will prevent exhaust gases from leaking.
- Steam or condensed water may drip out of the flue terminal. Dispose of this condensed water according to local codes and in order to prevent injury or property damage.
- If this product will be installed in an area where snow is known to accumulate, protect the flue termination from blockage by snow drifts or damage from snow falling off of roofs.
- Support the flue pipe with hangers at intervals.
- Install the flue terminal so that it is easily accessible for maintenance both from the indoors and the outdoors.

Type : B₂₃
(HORIZONTAL / VERTICAL FLUE TERMINAL)

- Disconnect power and turn ON Dip switch No.3 and No.5 if install flue type B₂₃.
- Refer to page 14 for the location of the Dip switch bank.
- Air intake basket is required for the air intake.

* DIP switch No.3 and No.5 is turned on.

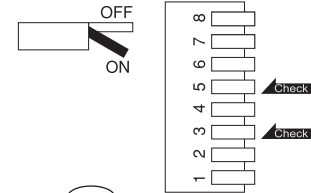

⚠ WARNING

- CO Alarm mandatory when water heater installed in B₂₃ type.
- CO Alarm should be connected with water heater like page 20 or installed in boiler room.

Flue system installation example

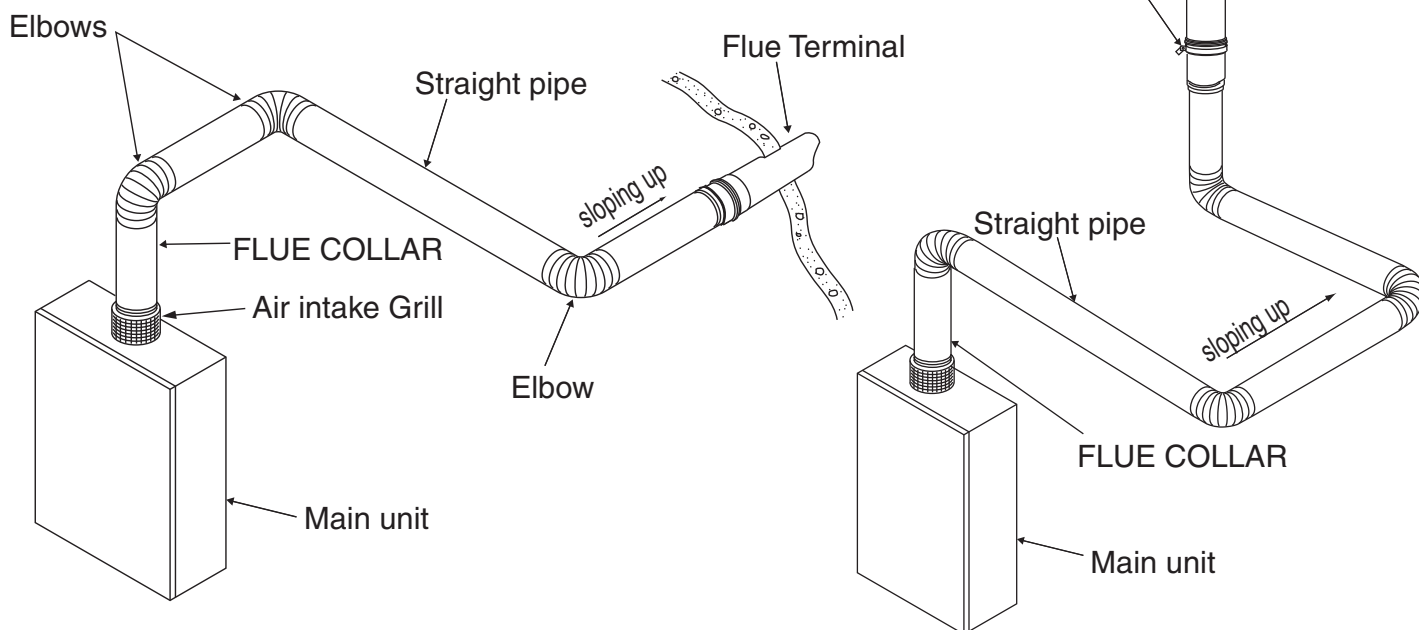

Flue Precautions

- Use 100mm diameter exhaust pipe.
- Maximum flue length
 4 elbow (90 degree) +
 5 m (exhaust pipe) + Flue Terminal
 *Maximum flue length : 13m
- Minimum flue length
 1 elbow (90 degree) + Flue Terminal
- Exceeding the maximum flue length is dangerous and may result in bad combustion.
- Maximum 90 degree bends not to exceed 4.
- Maximum length must be reduced by 2000mm for each 90° bend used.
- Maximum length must be reduced by 1000mm for each 45° bend used.
- If possible, don't install the flue pipe through any enclosed areas. If necessary, consult ANDREWS WATER HEATER for clearances.
- Install the flue terminal so that all exhaust is directed to outdoors.

- Do not store hazardous or flammable substances near the flue terminal.
- Slope the intake and exhaust pipes at a 1/20 grade up towards the termination.
- Connect the flue pipe firmly so that it will prevent exhaust gases from leaking.
- Steam or condensed water may drip out of the flue terminal. Dispose of this condensed water according to local codes and in order to prevent injury or property damage.
- If this product will be installed in an area where snow is known to accumulate, protect the flue termination from blockage by snow drifts or damage from snow falling off of roofs.
- Support the flue pipe with brackets at intervals.
- Install the flue terminal so that it is easily accessible for maintenance both from the indoors and the outdoors.

Combustion Air

- Provide two permanent openings to allow circulation of combustion air.
- Make each opening 0.13m^2 if they provide indoor air, and 0.065m^2 for outdoor air.
- If the unit is installed in a mechanical closet, provide a 600mm clearance in front of the unit to the door.
- If combustion air will be provided through a duct, size the duct to provide 1.7m^3 of fresh air per minute.

WARNING

DO NOT install the water heater in an area of negative pressure in case of B type.

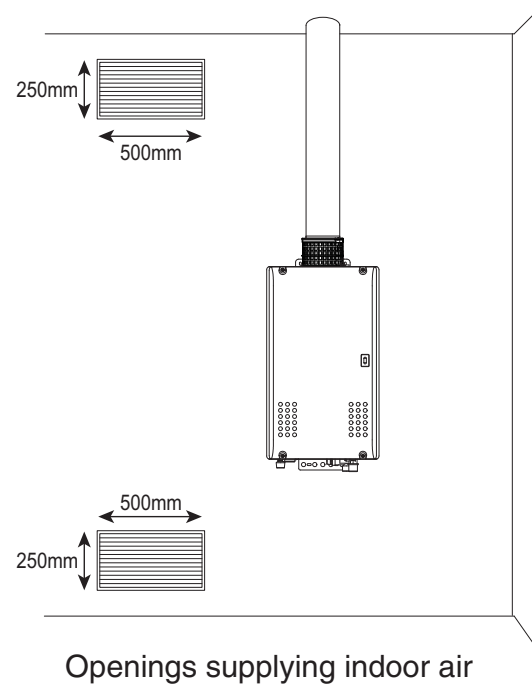

CO Alarm Connection (only B23 type)

If any reversed exhaust flow malfunction occurs, the following condition applies, all units stop their operation for safety.

To prevent the system-down like above, Noritz recommends to install CO alarm.

Refer to following instruction. When CO Alarm be connected and carried out trial run in accordance with the procedure, system-down situations can be canceled.

* If the CO Alarm operates, then the system will shutdown for safety. Error Code <13>

Resolve the cause of the CO detection and then press the Power button twice to restore operation.

**On a Multi system with System controller, system shutdown will occur when the System Controller is broken.

CO Alarm Requirements

<Required>

- No voltage break contact (Normally Closed Contact) output, or connectable to a relay module with No voltage break contact output.
Contact Rating: more than 2.7 mA @ 15VDC.
- Break contact output when pressing (ex.) TEST / RESET / HUSH Button on CO Alarm. CO Alarm has a visual indication of operation.

<Recommended>

- Has 220 - 240 V AC 60 Hz connection and/or auxiliary battery power.
- It has a warning function of End of the CO Alarm's Life.

Warning

Be sure to maintain the CO Alarm in accordance with CO Alarm's User Manual for safety.
When the CO Alarm reaches the end of service life, be sure to replace immediately.

Procedure for CO Alarm connection <Quick Connect>

- 1** Disconnect power to all units and CO Alarms before the installation of electrical wiring.
Install 2 CO Alarms (and Relay modules) in accordance with CO Alarm's Installation Manual.

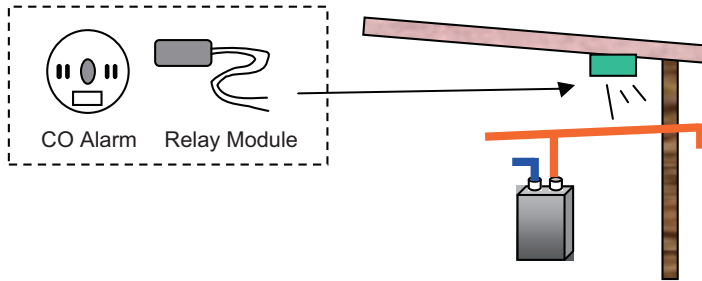

* Install the CO Alarms in the same room where the units are installed.

- 2** Cut the CO Alarm (Looped Brown) wire in each unit.
Connect the CO Alarm (Brown) wires to CO Alarm's Break contact (Normally Closed).

! DANGER

DO NOT supply any voltage in this circuit.

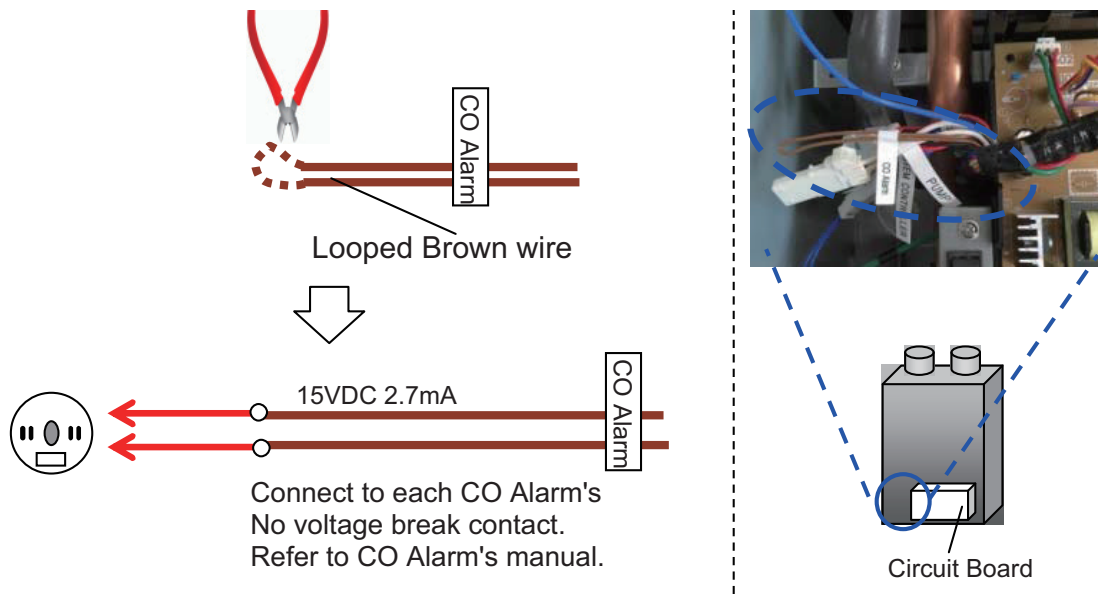

- 3** Connect power to all units and CO Alarms
* Confirm the Remote Controller doesn't show any error messages.
The system will not recognize the CO Alarm while the Remote Controller is showing an error message.

- 4**  Press the TEST Button on each CO Alarms

* Complete this CO Alarm test procedure within the first 10 minutes after connecting power to the units.

9. Gas Piping

Follow the instructions from the gas supplier.

The appliance and its individual shutoff valve must be disconnected from the gas supply piping system during any pressure testing of that system at test pressures in excess of 35 mbar.

The Appliance must be isolated from the gas supply piping system by closing its individual manual shutoff valve during any pressure testing of the gas supply piping system at test pressures equal to or less than 35 mbar.

The appliance and its gas connections must be leak tested before placing the appliance in operation.

The inlet gas pressure must be within the range specified. This is for the purposes of input adjustment.

Measuring Gas Pressure

In order to check the gas supply pressure to the unit, a pressure measurement port is provided on the gas inlet. Remove the hex head screw from the pressure measurement port, and connect a manometer using a silicon tube.

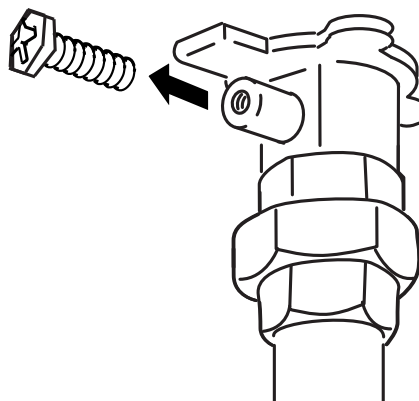

10. Water Piping

Ask a qualified plumber to perform the installation of the plumbing. Observe all applicable codes.

This appliance is not intended for use with potable water. Do not use this appliance if any part has been underwater. Immediately call a qualified service technician to inspect the appliance and replace any part of the control system and gas control which has been under water.

If the water heater is installed in a closed water supply system, two double non return valves must be installed between the heater and the cold water mains supply and means shall be provided to control thermal expansion with the use of a suitably sized expansion vessel.

Piping and components connected to the water heater shall be resistant to corrosion. Toxic chemicals, such as those used for boiler treatment, shall not be introduced into the system.

When water is required in one part of the system at a higher temperature than in the rest of the system, means such as a mixing valve shall be installed to temper the water to reduce the scalding hazard.

- Flush water through the pipe to clean out metal powder, sand and dirt before connecting it.
- Take appropriate heat insulation measures (e.g., wrapping with heat insulation materials, using electric heaters) according to the climate of the region to prevent the pipe from freezing.
- Use a union coupling or flexible pipe for connecting the pipes to reduce the force applied to the piping.
- Do not use piping with a diameter smaller than the coupling.
- When feed water pressure is too high, insert a depressurizing valve, or take water hammer prevention measures.
- Avoid using joints as much as possible to keep the piping simple.
- Avoid piping in which an air holdup can occur.
- Use approved piping materials.
- If installing the unit on a roof:

If the unit is installed on a roof to supply water to the levels below, make sure that the water pressure supplied to the unit does not drop below 2000 mbar. It may be necessary to install a pump system to ensure that the water pressure is maintained at this level.

Check the pressure before putting the unit into operation.

Failing to supply the proper pressure to the unit may result in noisy operation, shorter lifetime of the unit, and may cause the unit to shut down frequently.

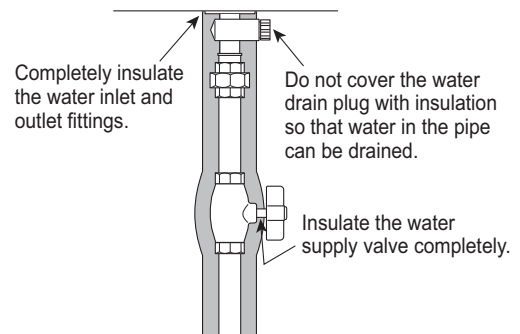

Supply water piping

- Do not use PVC piping.
- Mount a check valve and a shut off valve (near the inlet).
- In order for the client to use the water heater comfortably, 1000 mbar to 5000 mbar of pressure is needed from the water supply. Be sure to check the water pressure. If the water pressure is low, the water heater cannot perform to its full capability, and may become a source of trouble for the client.

Drain piping

- Expansion water may drop from the pressure prevention device and wet the floor. If necessary, provide drain piping or use a drain hose to remove the water.

Hot water piping

- Do not use lead or PVC piping.
- The longer the piping, the greater the heat loss. Try to make the piping as short as possible.
- Use a mixing valve with a low water resistance. Use shower heads with low pressure loss.
- If necessary, use a pump or other means to ensure that the supply water pressure to the inlet of the heater does not fall below 2000 mbar when the maximum amount of water is being demanded. Also install a pressure meter on the inlet. If this is not done, local boiling will occur inside the water heater causing abnormal sounds and decreasing the durability of the heat exchanger.

WATER QUARITY

If the heater is in a hard water area a suitable water conditioning device must be installed to prevent the build up of limescale within the heat exchanger. Heat exchangers damaged by scaling are not covered by the manufacturer's warranty.

Description	pH	Total Dissolved solids (TDS)	Total Hardness	Chlorides	Magnesium	Calcium	Sodium	Iron
Maximum Recommended Levels	6.5 - 9.0	500 mg/liter	150 mg/liter	250 mg/liter	10 mg/liter	20 mg/liter	180 mg/liter	1 mg/liter

11. Electrical Wiring

Consult a qualified electrician for the electrical work.



Do not connect electrical power to the unit until all electrical wiring has been completed.

- i) "A means of disconnection from the supply mains having a contact separation in all poles must be provided to allow for full disconnection".
- ii) Under voltage Cat III conditions should be incorporated in the fixed wiring in accordance with the wiring regulations.
- iii) "If the supply cord is damaged, it must be replaced by the manufacturer or its service agent".

This appliance must be electrically grounded in accordance with Electrical Authority Regulations.

External wiring must be correctly earthed, polarised and in accordance with the relevant standards.

In GB this is BS 6891.

In IE this is the current edition of I.S.813 "Domestic Gas Installations".

The boiler must be connected to a permanent 220 - 240 V AC, 50Hz supply.

Connection of the whole electrical system of the boiler, including any heating controls, to the electrical supply must be through one common isolator and must be fused 10 Amp maximum.

Isolation should be by a double pole switched fused spur box, with a minimum gap of 3 mm for both poles. The fused spur box should be readily accessible and preferably adjacent to the appliance.

It should be identified as to its use.

Caution: Label all wires prior to disconnection when servicing controls. Wiring errors can cause improper and dangerous operation.

Verify proper operation after servicing.

Field wiring to be performed at time of appliance installation.



Caution

Do not turn on the power until the electrical wiring is finished. This may cause electrical shock or damage to the equipment to occur.

- The electrical supply required by the water heater is 220 - 240V AC at 50 Hz. As the electric power consumption varies depending on the gas type, check it with the rating plate or higher if using optional accessories. Use an appropriate circuit.
- Do not disconnect the power supply when not in use. When the power is off, the freeze prevention in the water heater will not activate, resulting in possible freezing damage.

- Do not let the power cord contact the gas piping.

Tie the redundant power cord outside the water heater. Putting the redundant length of cord inside the water heater may cause electrical interference and faulty operation.

Ground

- To prevent an electric shock, always plug power lead into an earth powerpoint.

THE APPLIANCE MUST BE EARTHED

Remote Controller

- Applicable Model

		WHi49, LWHi49
Remote controller	Main	RC-9018M

- The remote controller must be installed in accordance with the installation manual enclosed in the package.

Connecting Remote Controller Cord to Unit

- Keep the remote controller cord away from the freeze prevention heaters in the unit.
- Tie the redundant cord outside the water heater. Do not put the extra length inside the equipment.
- The remote controller cord can be extended up to 100m with Remote controller cord.
- Use a Y type terminal with a resin sleeve. (Without the sleeve, the copper wire may corrode and cause problems).
- Be sure to hand tighten when screwing to the terminal block. Power tools may cause damage to the terminal block.

Remote controller cord

- Use Remote controller cord for any extensions.
- Install according to the National Electrical Code and all applicable local codes.

1. Disconnect electrical power to the water heater.
2. Leave enough slack so that the remote controller cord will not be damaged if the unit is removed from the wall.
3. Remove the front cover of the heater (4 screws).
4. Pass the remote controller cord through the wiring throughway and into the unit.
5. Connect the Y terminals at the end of the remote controller cord to the terminal block.
6. Secure the remote controller cord with a clamp.
7. Replace the front cover.

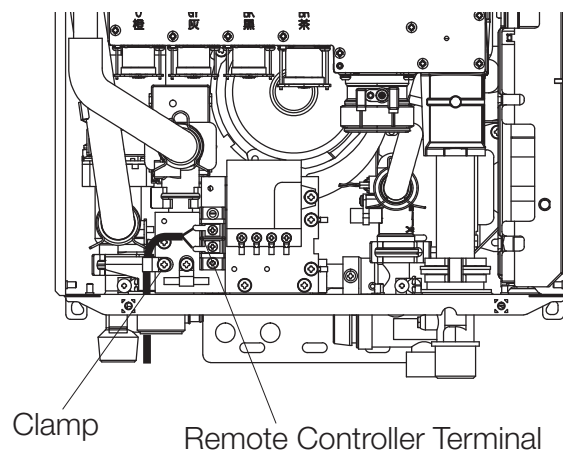

Connecting Quick Connect Cord-2

For Quick Connect Multi System Installation use part Quick Connect Cord-2 only. (sold separately).

Caution

The wire coloring on the Quick Connect Cord-2 will not be the same as the wire coloring of the connection plug inside the unit.

* The remote controller can be connected to either unit A or B. Do not connect a remote controller to both units.

* Disconnect the remote controller from either unit A or B prior to installing the Quick Connect Cord-2.

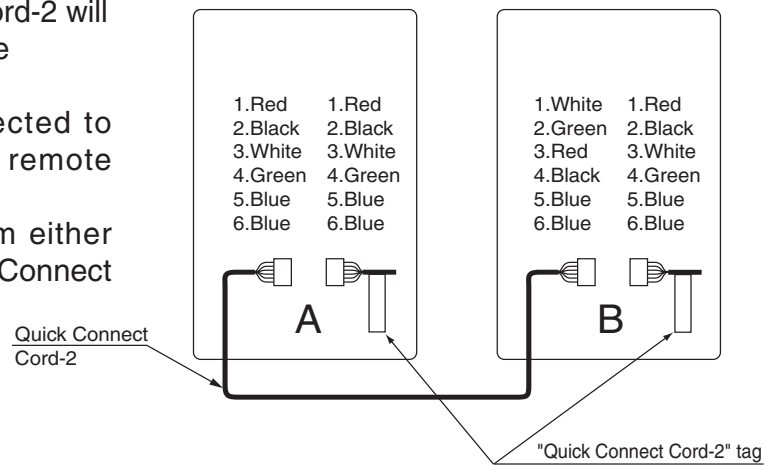

Connecting the Quick Connect Cord-2 to the two units.

1. Turn off the power.
2. Remove the front cover of the heater (4 screws).
3. Pass the Quick Connect Cord-2 through the wiring throughway and into the unit.
4. Plug the connector on the Quick Connect Cord-2 to the receptacle inside the unit.
5. Attach the ground wire of the Quick Connect Cord-2 to the terminal block fixing plate. (If the ground wire is not attached, electrical noise may cause problems).
6. Secure the Quick Connect Cord-2 with a clamp.
7. Replace the front cover.

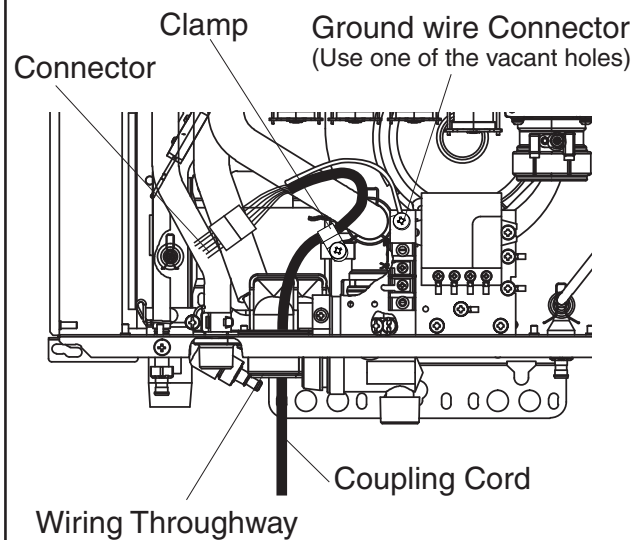

Remote Controller

Installation Guide

Requests to Installers

- In order to use the water heater safely, read this installation guide carefully, and follow the installation instructions.
- Failures and damage caused by erroneous work or work not as instructed in this manual are not covered by the warranty.
- Refer to the Installation Manual provided with the water heater for complete installation details.

In order to use this product safely, read this installation manual carefully and follow the installation instructions.

- Potential dangers from accidents during installation and use are described below. Closely observe these warnings, they are critical to your safety.



CAUTION

CAUTION indicates a potentially hazardous situation which, if not avoided, may result in minor or moderate injury.



CAUTION

The remote controller is not water resistant. Keep it dry.



CAUTION

- Do not connect power to the system unit until the remote controller installation is complete.
- Be sure to fasten the mounting screws tightly by hand so that the remote controller will be secure.
 - * Do not use electric drivers, impact drivers and so forth. Tightening with excessive force may cause the mounting bracket to be damaged and lead to failures.
- Install the remote controller on an even wall surface.
 - * Installing it on an uneven wall surface may cause the bracket to be damaged and lead to failures.
- This remote controller has a built-in speaker which can be damaged by metal shavings resulting in sound cracking.
Keep the remote controller in a safe location prior to mounting it on the wall to prevent metal shavings from entering the remote controller.

Note

- Cutting too large of a hole on the wall may result in failure to properly secure the remote controller.
- Never fasten or loosen unnecessary screws in order to complete the remote controller installation.
- Be sure to check the positions of wall studs or other obstructions when determining the installation location for the remote controller.
- Secure the remote controller cable with appropriate anchors, ties, etc.
- Wire the remote controller cable in an area where it will not be directly affected by heat.
- To embed the remote controller cable in concrete, brick, etc., enclose it in conduit in order to prevent the remote controller cable from becoming damaged.
- When penetrating a wall containing metal lath, prevent the lath from coming into contact with any metallic conduit used in order to prevent electrical interference.
- Wiring shall be provided so that the remote controller cable length is 100m or shorter.
- Connect the remote controller cable to the terminal block of the water heater (see Installation Manual provided with the water heater).



Post-installation Checks

- (1) Check if the remote controller is installed securely.
- (2) Verify remote controller operation (see OPERATING INSTRUCTIONS).
- * Press the Power On/Off button approximately 5 seconds after connecting power to the system.
- * Check if the temperature setting on the remote controller is appropriate.

Explanation to the Customer

Explain the “Important Safety Information”, “Operation Procedures” and “Follow-up Service” according to the Owner's Guide supplied with the water heater.

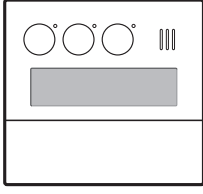
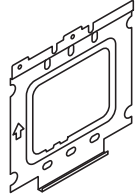
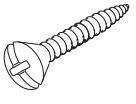
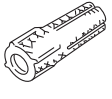
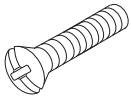
Included Parts List (The value in () indicates the quantity.)

Remote Controller	Mounting bracket	Raised countersunk head wood screw	Wall anchor	Raised countersunk head screw	Machine screw
(1) 	(1) 	(2) 	(2) 	(2)  <small>(For junction box installation)</small>	(2) 

Confirmation before the setting

■ Introduction

- Make sure that the power is not turned on (the breaker is “OFF” or the power plug of equipment is disconnected).
- Check the included parts list.

■ Confirmation before the setting

- Choose a place that is easy to use in consultation with our customers (It is necessary to get the approval of the visitor).
- Do not be attached to the following place;
 1. The place where the temperature becomes higher (near a gas stove)
 2. The place where direct rays hit (near a window etc.)
 3. The place which requires steam (near a gas stove and a rice cooker etc.)
 4. The place which requires a spray (near a hot water tap etc.)
 5. The place which requires oil (near a gas stove)
 6. The place which uses chemical specialties (Benzine, Oils and fats system detergent etc.)

■ Confirmation before the setting of the remote-control cord

The remote controller cord can be extended up to 100m. Please use the thing of required length according to the conditions of the spot.

By splicing the cord and using 18 gauge wire to extend the cord to the appropriate length. For using it, please be sure to attach Y-shaped terminal with a resin sleeve.

Be careful for a mustache not to come out.

When a mustache comes out, please be sure to reattach Y-shaped terminal.

A mustache contacts other parts and causes failure of apparatus.

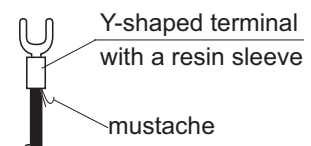

Installation

1. Attach the mounting bracket to the wall.
The parts to be used vary depending on the attachment method.

* Never use electric drivers, impact drivers and so forth. Tightening with excessive force may result in deformation of the mounting bracket and/or failures.

<When attaching to a junction box>

- Use the raised countersunk head screws to attach the mounting bracket to the junction box. (In this case, the wall anchor and round countersunk head wood screws are not used.)

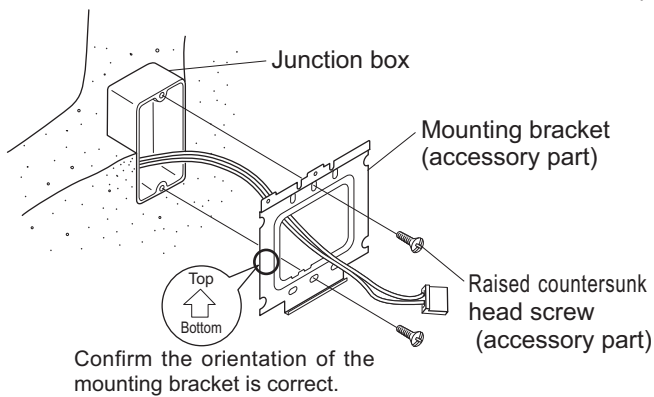

<When attaching to a wood surface>

- Use the raised countersunk head wood screws to attach the mounting bracket. (In this case, the wall anchor and raised countersunk head screws are not used.)

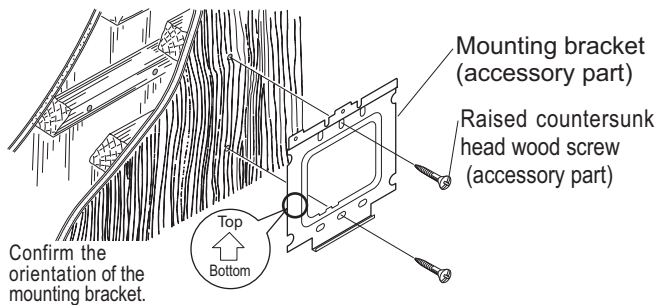

<When attaching to a concrete wall surface>

- Drill a $\phi 6\text{mm}$ hole, approx. 25mm~30mm in depth, and hammer in the wall anchor. Attach the mounting bracket using the raised countersunk head wood screws. (In this case, raised countersunk head screws are not used.)

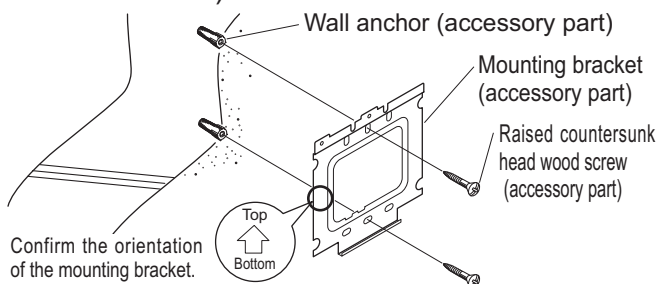

2. Remove the decorative frame from the remote controller.
(The remote controller is inserted in the decorative frame.)

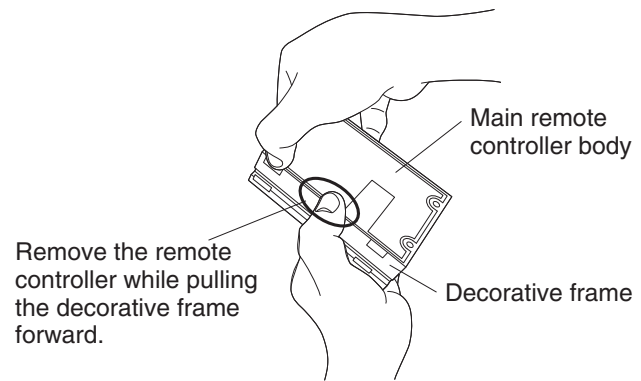

3. Connect a Y-shaped terminal of the remote control cord to a terminal stand of the remote control in back side.

Push down only section A (▨) of an insulated cover (clear) to the front, and attach Y-shaped terminal from an insulated cover (clear) top side.

* Do not remove the insulating cover (clear).
* Be careful about the installation direction of the Y-shaped terminal.
* Do use an electric driver, the impact screwdriver absolutely. The position of a terminal stand changes with kinds of remote control.

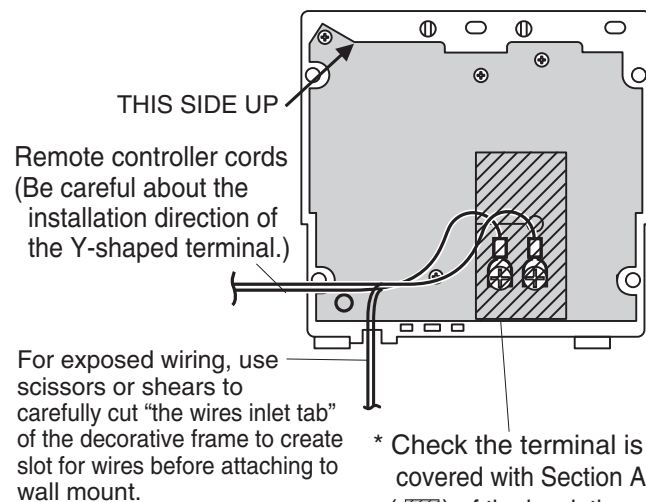

* Check the terminal is covered with Section A (▨) of the insulating cover (clear, see Fig. 1).

* If the Y-shaped terminal is not covered, the exposed section may come into contact with the mounting bracket resulting in improper operation or failure.

4. Secure the remote controller cords by winding them around the notches as shown in Fig. 1.

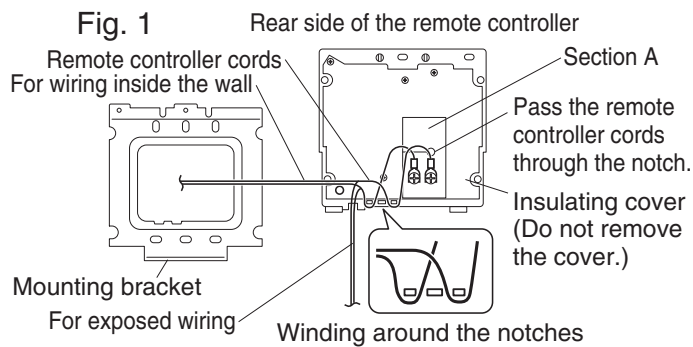

5. Attach the remote controller to the mounting bracket. Insert the bottom of the remote controller into the groove at the bottom of the bracket and push in the 2 hooks on top of the remote controller completely.

* If it is difficult to attach, do not try to force it as it may result in broken hooks. Check for proper alignment in the groove or for loose wires obstructing the remote controller.

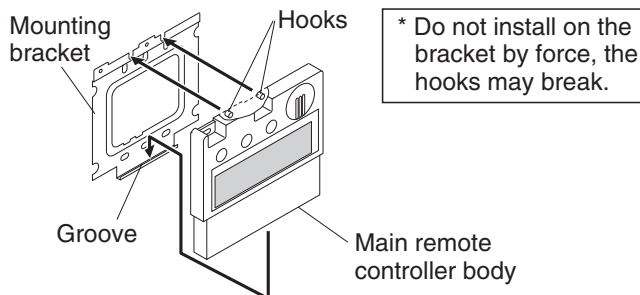

6. Secure the remote using the machine screws.

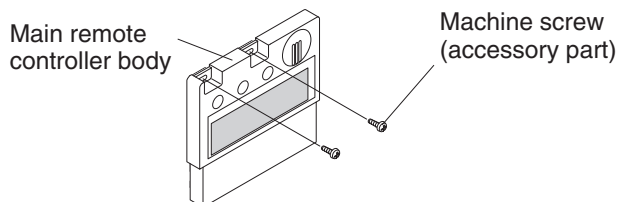

7. Attach the decorative frame which was removed in the second step.

Push the 4 corners of the decorative frame until there is a click.

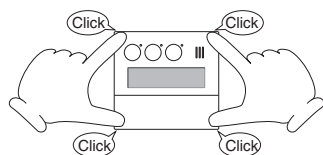

* Incomplete installation may result in failures such as switch operation failure.

Note: To remove the decorative frame after installation of the remote controller and the frame, pull the entire decorative frame forward while pressing the sections indicated (where the fingers are) in the figure below.

* If it does not come off, insert a flat head driver into the notch at the bottom of the decorative frame and slightly twist it to remove (due caution is required not to scratch the remote controller, decorative frame or the wall in doing so).

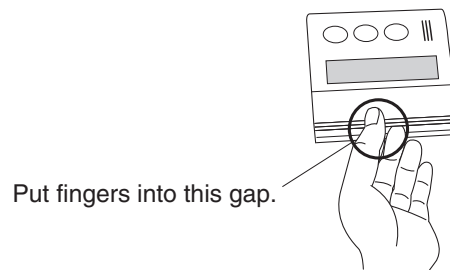

13. Trial Operation

The installer should test operate the unit, explain to the customer how to use the unit, and give the owner this manual before leaving the installation.

- Preparation (1) Open a hot water fixture to confirm that water is available, and then close the fixture.
(2) Open the gas supply valve.
(3) Turn on the power supply. Using the remote controller, turn on the Power ON/OFF button (the Operation lamp will turn on).
- (1) Open a hot water fixture and confirm that the Burner on lamp comes on, and that hot water is being produced. (If necessary, repeat until the air in the gas piping is bled out).
 - * White smoke may be noticed from the exhaust vent during cold weather. However, this is not a malfunction of the unit.
 - * If an "11" error code appears on the remote controller, turn the unit off and then back on again, and then open a hot water fixture again.
- (2) Change the temperature setting on the remote controller and check that the water temperature changes.
- If the water heater does not operate normally, refer to "Troubleshooting" in the Owner's Guide.
- * After the trial operation, clean the filter in the cold water inlet.

<If installed with a quick connect multi-system>

- Turn the system power ON with the remote controller.
- Slowly open a hot water fixture and check that the units ignite sequentially. Check to see that the hot water temperature is the same as the temperature displayed on the remote controller (*1)

* If both units do not ignite, switch which unit will ignite first by pressing the Max. or Min. Manifold Pressure Set Button on the circuit board. (*2)

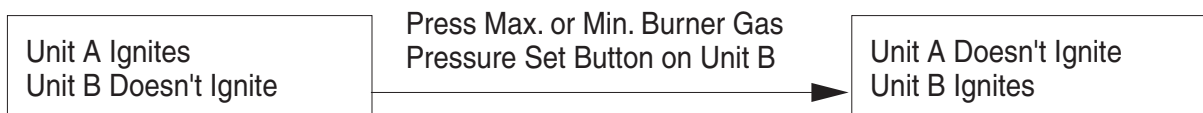

* If an 11 or F11 error code flashes on the remote controller, hit the Power Button on the remote controller off and on 2-3 times.

* If (*1) and (*2) cannot be done, the Quick Connect Cord-2 may not be properly connected. Check that the cord is properly connected.

CAUTION

Handling after trial operation

- If the unit will not be used immediately, close off all gas and water shut off valves, drain all of the water out of the unit and the plumbing system to prevent the unit and system from freezing, and bleed the gas out of the gas line.
Freezing is not covered by the warranty.

**WARNING**

A fire or explosion may result if these instructions are not followed, which may cause loss of life, personal injury or property damage.

Lighting Instructions

This water heater does not have a pilot. It is equipped with an ignition device that automatically lights the burner.

Do not try to light the burner by hand.

1. Read the safety information in the installation manual or on the right side of the water heater.
2. Turn off all electrical power to the unit.
3. Do not attempt to light the burner by hand.
4. Turn the gas control manual valve (external to the unit) clockwise to the off position.
5. Wait five minutes to clear out any gas. If the smell of gas remains, stop, and follow the instructions on page 3 of Owner's Guide.
6. Turn the gas control manual valve counterclockwise to the on position.
7. Turn on electric power to the unit.
8. The unit will now operate whenever hot water is called for. If the unit will not operate, follow the shutdown instructions and call a service technician.

Shutdown Instructions

1. Stop any water demand.
2. Turn off electric power.
3. Turn the gas control manual valve clockwise to the off position.

Should overheating occur, or the gas supply fail to shut off, turn off the manual control valve to the appliance.

14. Dimensions

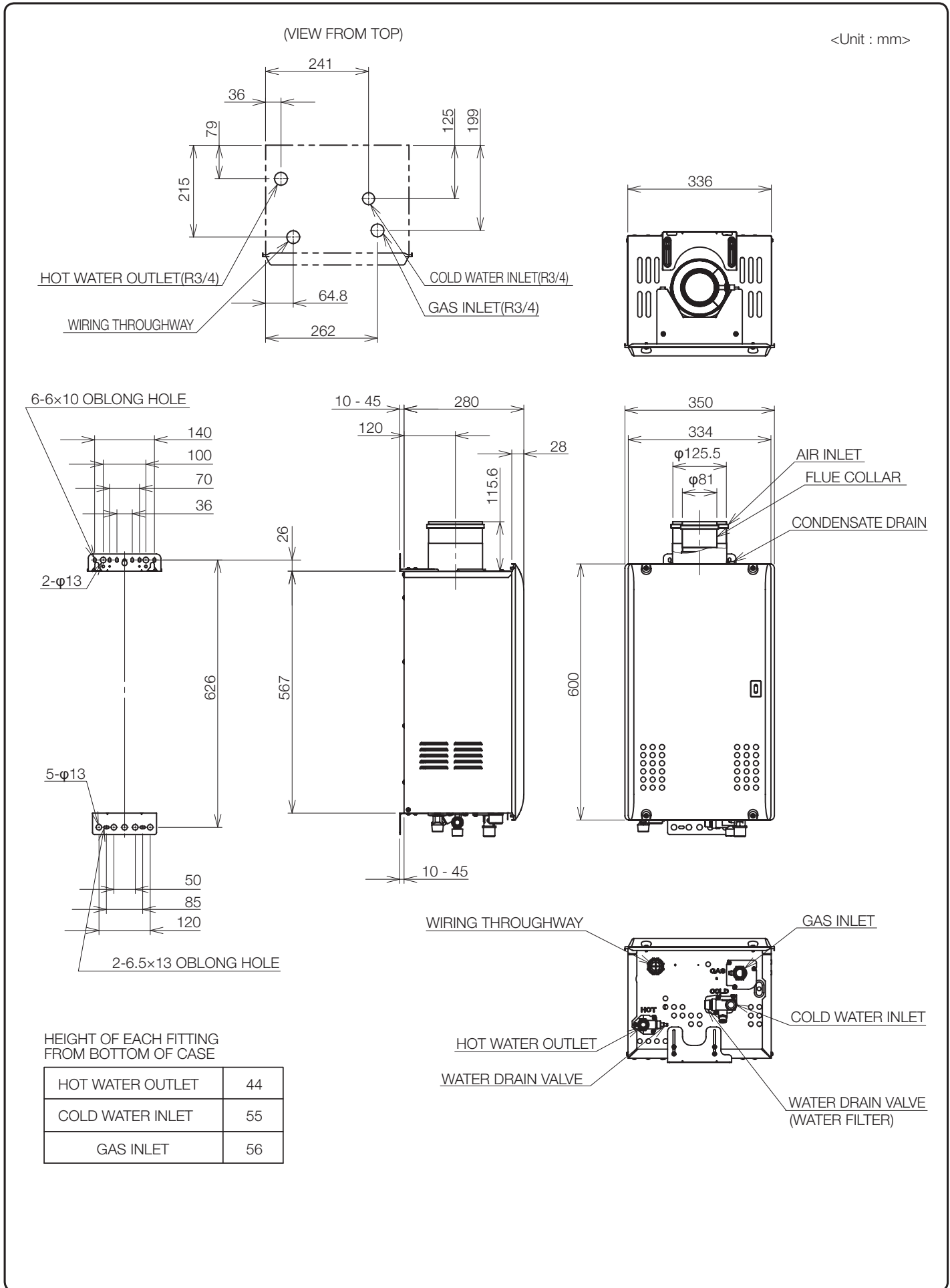

Wiring Diagram

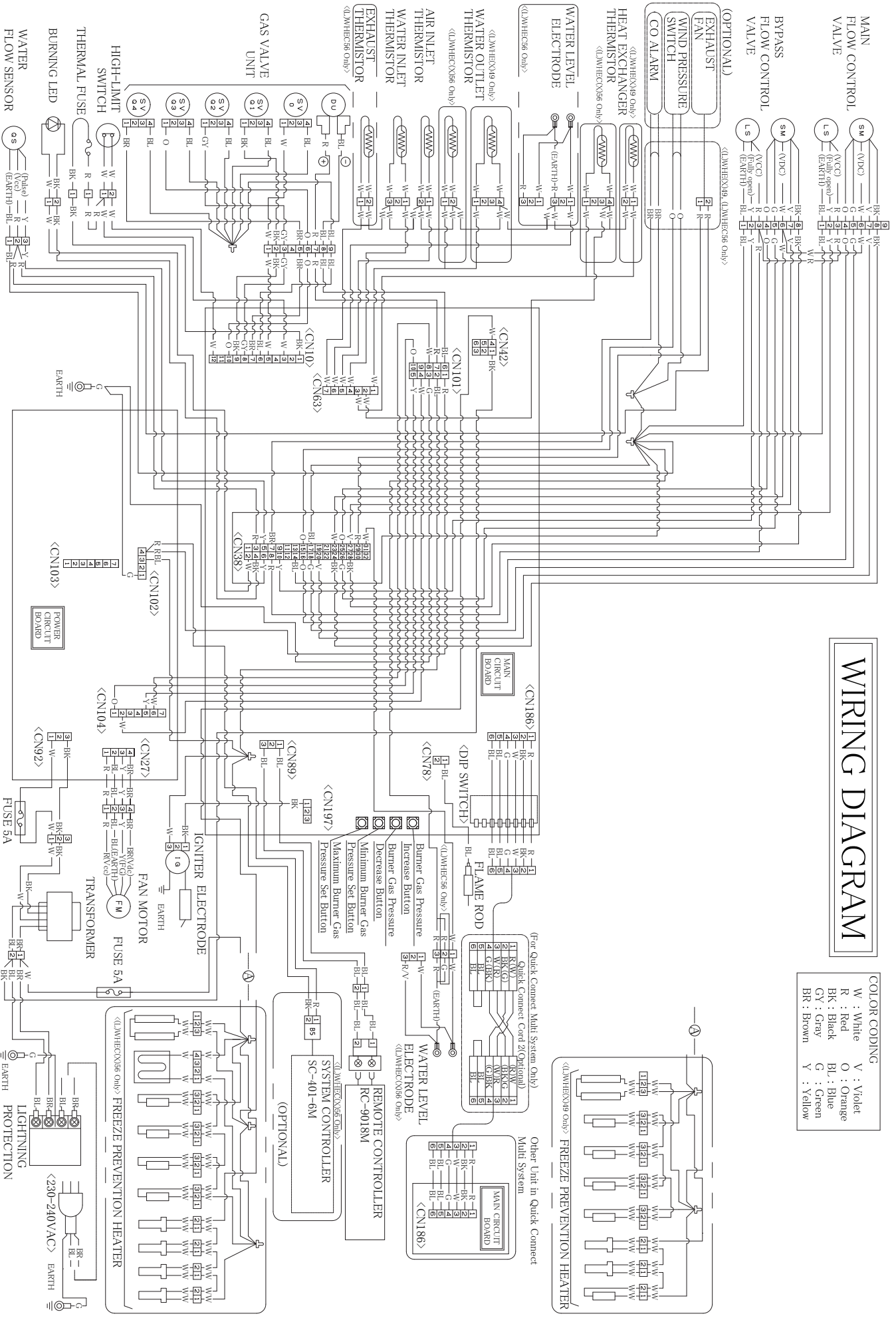

WIRING DIAGRAM

COLOR CODING	
W : White	V : Violet
R : Red	O : Orange
BK : Black	BL : Blue
GY : Gray	G : Green
BR : Brown	Y : Yellow

Wiring Diagram

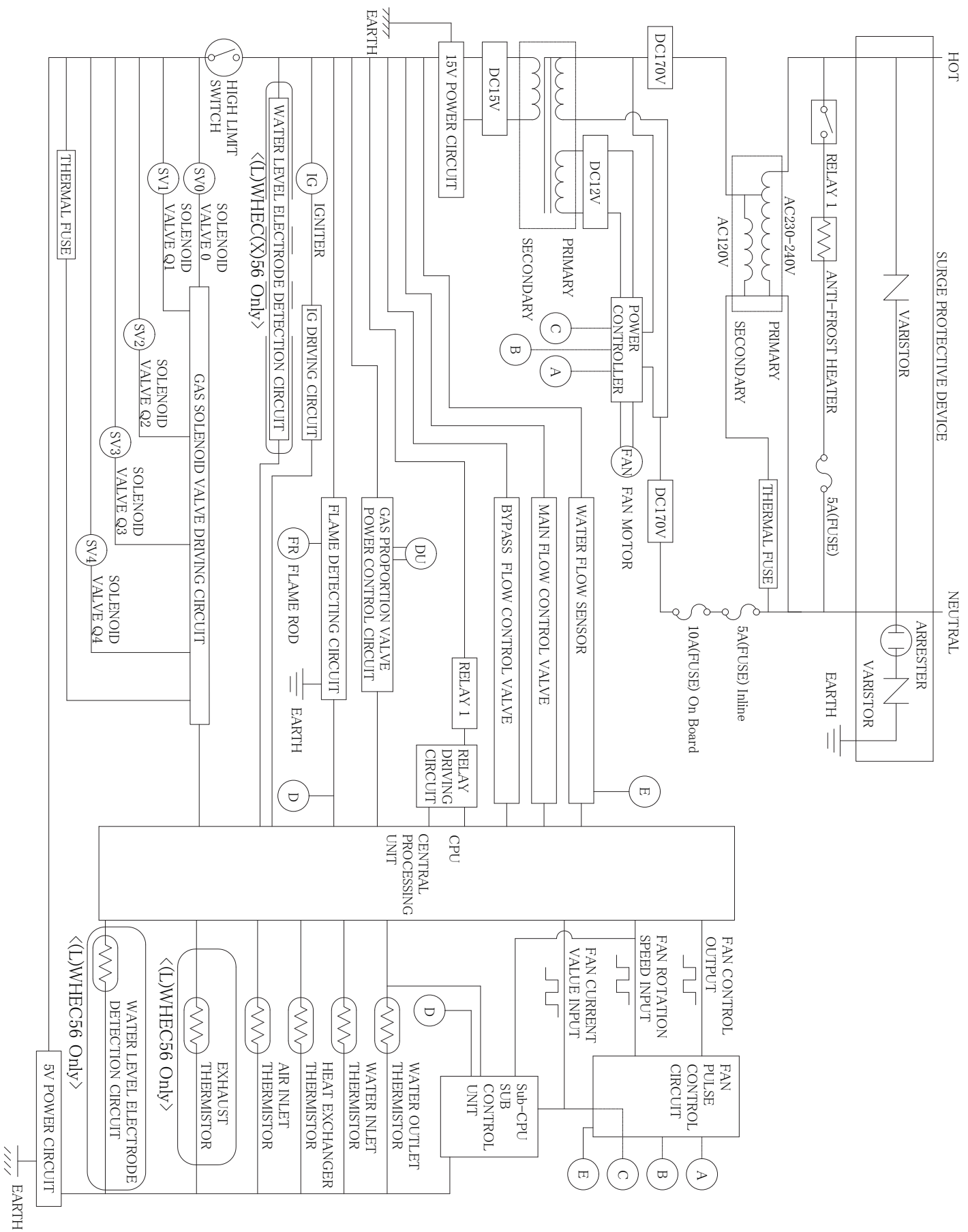



15. Maintenance

Periodically check the following to ensure proper operation of the water heater.

- The venting system must be examined periodically by a qualified service technician to check for any leaks or corrosion.
- The burner flame must be checked periodically for a proper blue colour and consistency.
- If the flame does not appear normal, the burner may need to be cleaned.
- If the burner needs to be cleaned, it must be performed by a qualified service technician.
- Do not obstruct the flow of combustion and ventilation air.
- See Owner's Guide for further maintenance or consult Andrews Water Heaters for recommended service checks.

Warning: There is a scald potential if the output temperature is set too high.

Should overheating occur, or the gas supply fail to shut off, turn off the manual gas control valve to the appliance. Do not use this appliance if any part has been under water. Immediately call a qualified service technician to inspect the appliance and to replace any part of the control system and any gas control which has been under water.

Periodically check and clean the filter inside the cold water inlet of the unit.

16. Specifications

- Specifications may be changed without prior notice.
- The capacity may differ slightly, depending on the water pressure, water supply, piping conditions, and water temperature.

Specifications

Item		Specification	
Model Name		WHi49	LWHi49
Type	Installation Air Supply/Exhaust	Internal, Wall Mounted Power Vented	
Ignition		Direct Ignition	
Minimum Pressure for Maximum flow		2.0 bar	
Minimum Flow Rate		2.0 L/min.	
Dimensions		60 cm(Height) x 35 cm(Width) x 28 cm(Depth)	
Weight		28 kg	
Water Holding Capacity		1.0 Litre	
Connection Sizes	Water Inlet	R 3/4"	
	Hot Water Outlet	R 3/4"	
	Gas Inlet	R 3/4"	
Power Supply	Supply	220 - 240 V AC (50Hz)	
	Consumption	75.9W	81W
		Freeze Prevention 193W	
Materials	Casing	Zincified Steel Plate/Polyester Coating	
	Flue Collar	Stainless Steel	
	Heat Exchanger	Copper Sheeting, Copper Tubing	
Safety Devices		Flame Rod, Thermal Fuse, Pressure Relief Valve, Lightning Protection Device (ZNR), Overheat Prevention Device, Freezing Prevention Device, Fan Rotation Detector	
Accessories		Anchoring Screws	

Performance

Item		Maximum Performance	Minimum Performance
Gas Consumption (NET)	G20	49.0 kW	3.6 kW
	G31	49.0 kW	3.6 kW
Hot Water Capacity	25°C Rise	28 L/min.	
	58°C Rise	11 L/min.	
Capacity Range		2.0 - 37 L/min.	
Temperature Settings		37 - 48, 50, 55, 60, 65, 70, 75, 80, 85 °C	

ErP-Information

Technical parameters

Product name			Fastflo WHi49	Fastflo WHiX49	Fastflo LWHi49	Fastflo LWHiX49	Fastflo WHiC56	Fastflo WHiCX56	Fastflo LWHiC56	Fastflo LWHiCX56
Daily electricity consumption	Q_{elec}	kWh	0.233	0.205	0.202	0.216	0.227	0.194	0.227	0.215
Declared load profile			XXL	XXL	XXL	XXL	XXL	XXL	XXL	XXL
Sound power level, indoors	L_{WA}	dB	61	66	61	66	58	62	58	62
Daily fuel consumption	Q_{fuel}	kWh	30.433	30.321	29.779	30.114	26.334	26.211	26.494	25.895
Emissions of nitrogen oxides	NO_x	mg/kWh	42.6	32.5	48.8	36.8	42.4	41.5	42.3	50.3
Weekly fuel consumption with smart controls	$Q_{fuel, week, sm}$	kWh	-	-	-	-	-	-	-	-
Weekly electricity consumption with smart controls	$Q_{elec, week, sm}$	kWh	-	-	-	-	-	-	-	-
Weekly fuel consumption without smart controls	$Q_{fuel, week}$	kWh	213	212	208	211	184	183	185	181
Weekly electricity consumption without smart controls	$Q_{elec, week}$	kWh	2	1	1	2	2	1	2	2

17. Multi System

A. Installation without a recirculation system (Using external system controller) (Standard System)

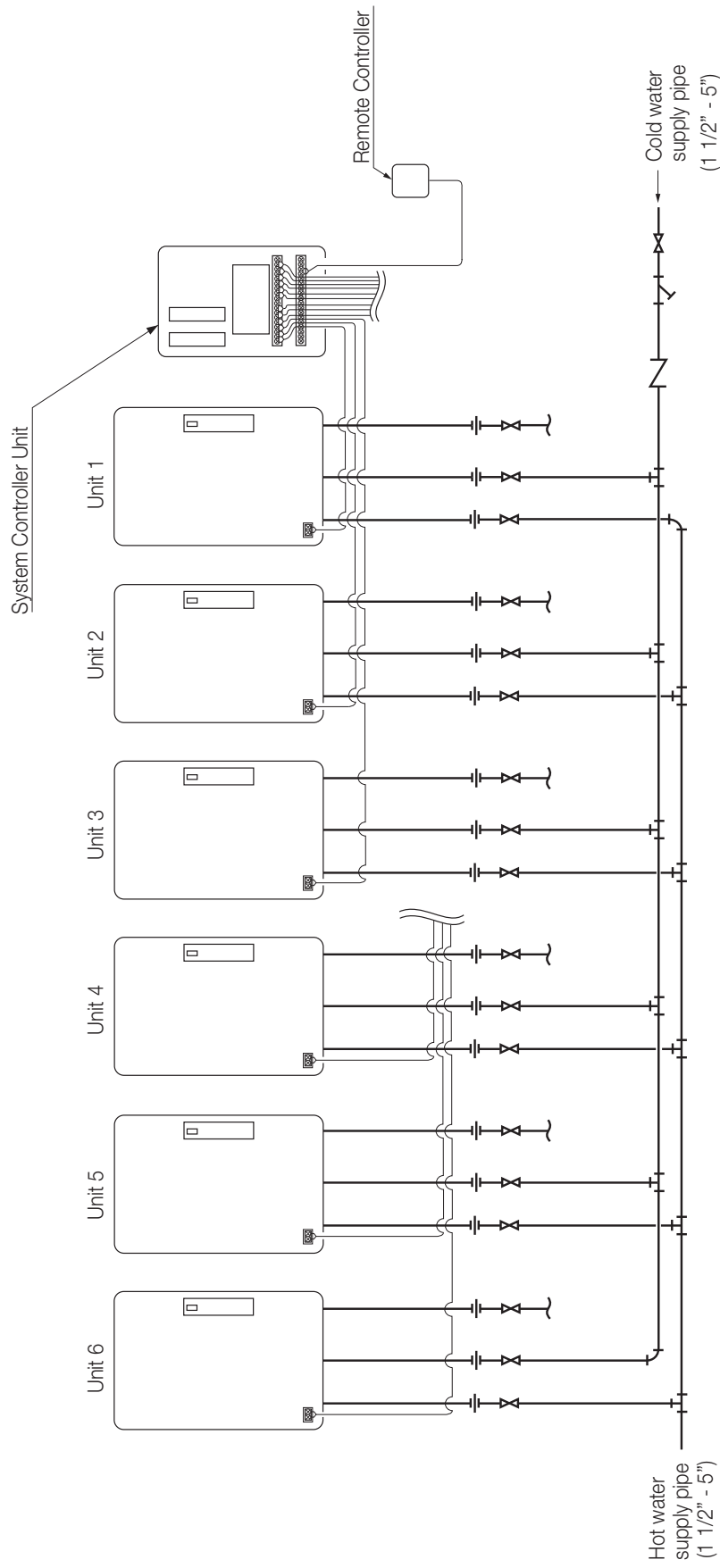

- Insulate or apply heating materials to both the cold water supply piping and the hot water supply piping to prevent freezing during cold weather and to prevent heat loss through the piping.

B-1. Example of Recirculation with a Multi-System (Using external system controller) (Recirculation system)

This system will make hot water more quickly available to remote fixtures.
The pump will circulate water through the loop until the entire loop is warm, and then the system controller will turn off the pump until the loop cools down.

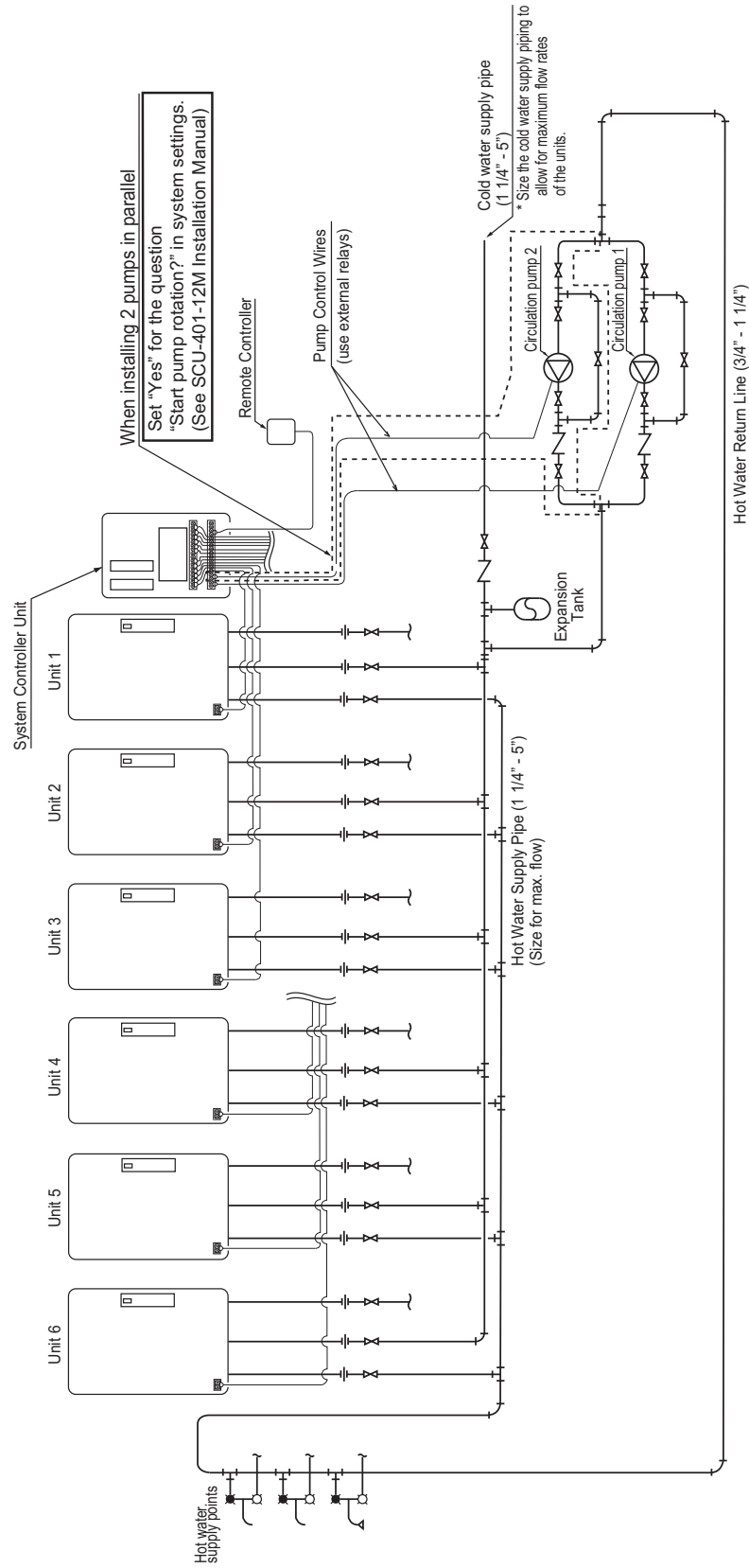

- * Size the pump to provide at least 8 L/min @ 3 m of head + piping losses through the system.
Check the maintenance monitors on the unit to make sure the pump is providing adequate flow.
- Make sure that the flow rate is not greater than 1.2 m/sec.
(3/4": 20 L/min, 1 1/4": 50 L/min)
If the flow is too low, the recirculation loop temperature will not be warm enough, if the flow is too high, the lifetime of the unit will be reduced.
- * If there are multiple circulation loops, try to make the flow rate .3-5 L/min in each loop.
- * Use copper or stainless water piping for the entire system.

B-2. Example of Installation with a Storage Tank and Recirculation System (Using external system controller)
(Tank recirculation system)

The pump will push water through the Multi-System to heat up the tank.
When the temperature of the thermostat is high, the system controller will turn off the pump until the temperature cools down.

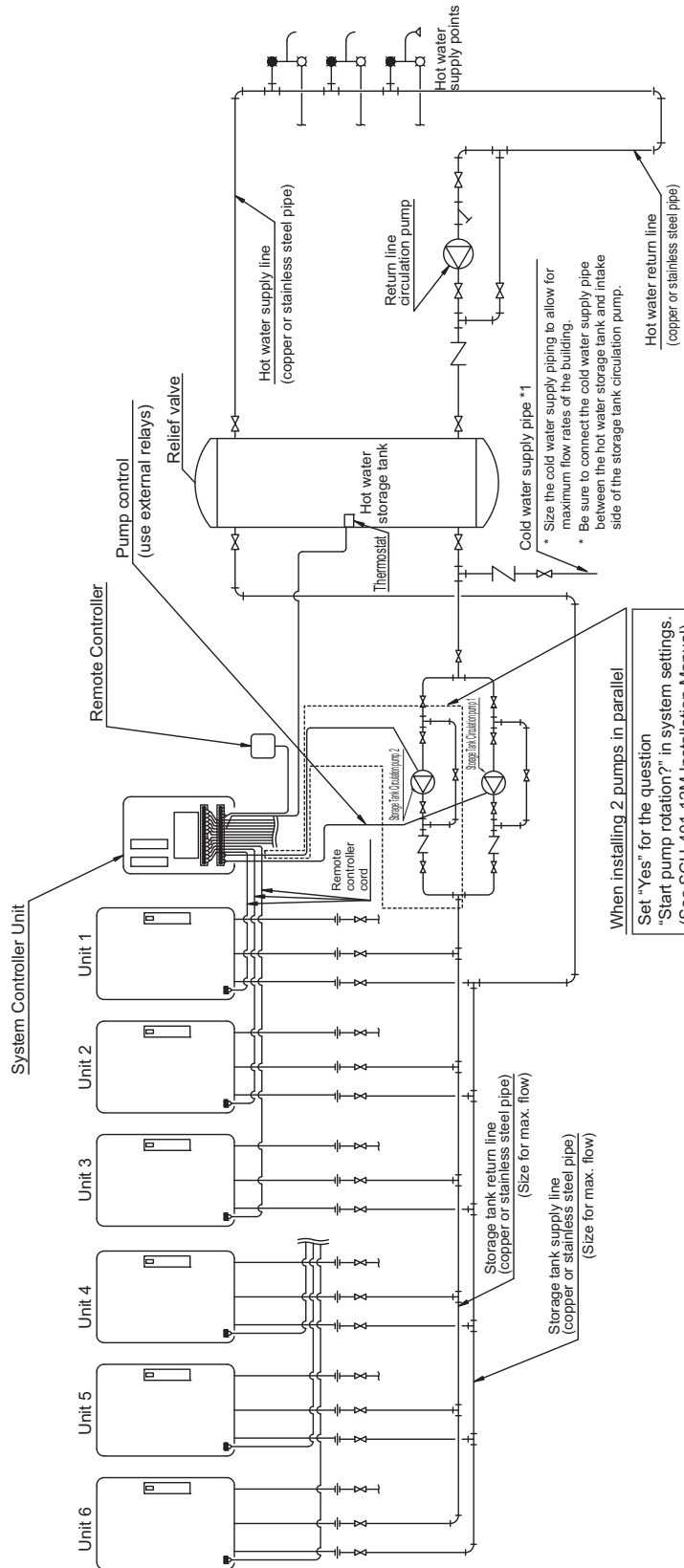

- * For the set temperature of the remote controller, use the temperature (of the thermostat) + about 5 °C.
- * To achieve the highest recovery, size the storage tank circulation pump for maximum capacity.
(32ECR6 : 34 L/min (each) @ 12 m of head, 28ENR6 : 26 L/min (each) @ 10 m of head (75 °C setting or less) + piping losses through the system.)
Verify the supply pressure to the units is at least 200 Kpa.

Multi-System Wiring (Use SCU-401-12M)

CAUTION

- The below diagram shows the connection of 3 units to the system controller. When connecting 4 or more units, follow the same procedure.
- Connect the water heaters to the system controller following the detailed wiring instructions included with the system controller.
- Always connect a remote controller to the system controller. Do not connect the included remote controllers to the individual water heaters. These remote controllers will not be used.

* The remote controller terminal location may differ depending on the unit.

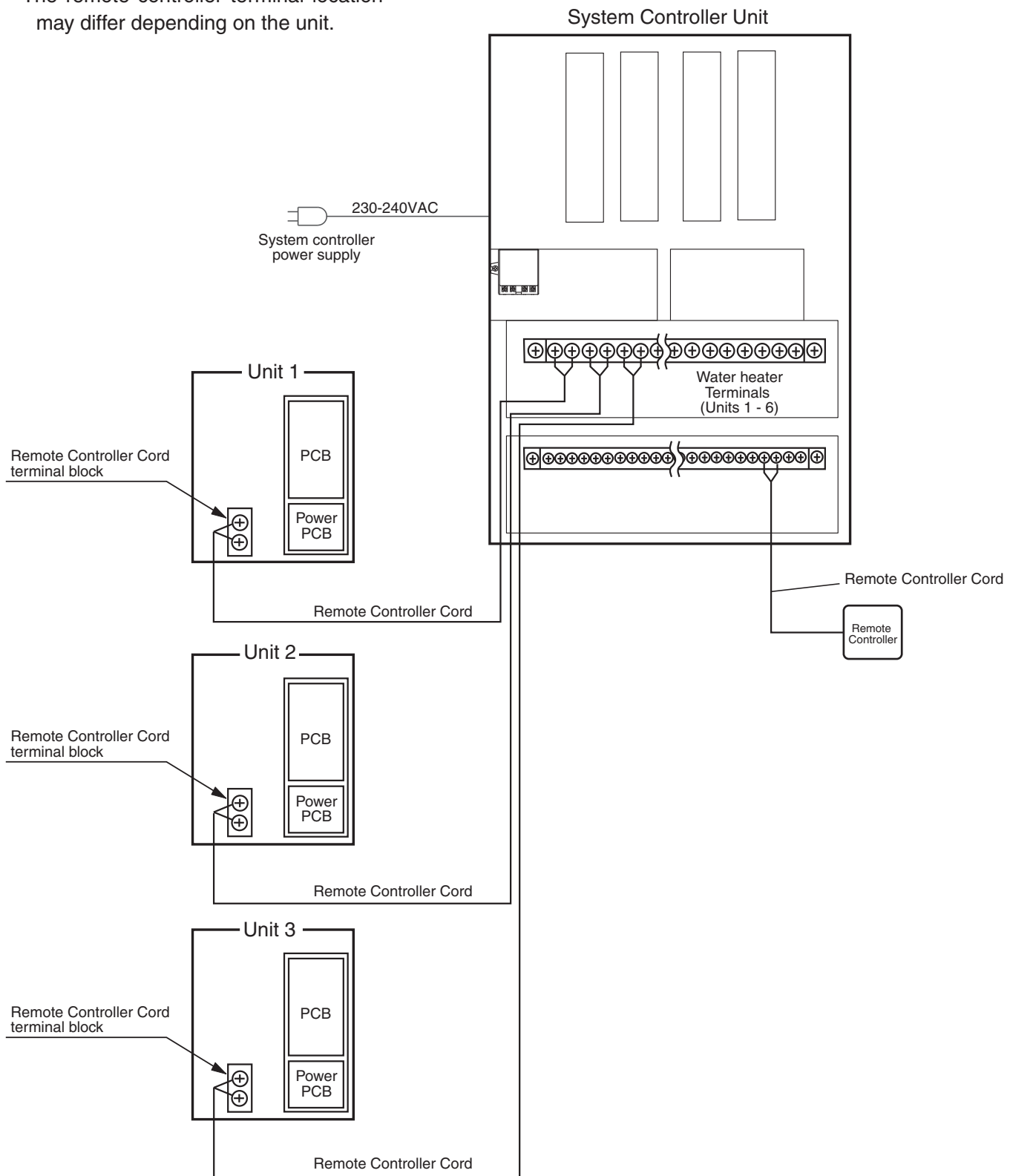

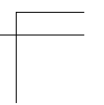
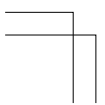
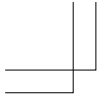

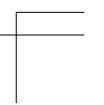
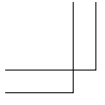

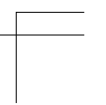
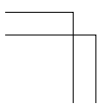
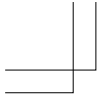



Register now to activate your warranty www.andrewswaterheaters.co.uk/register-a-warranty. Please make sure you attach proof of purchase for your warranty to be monitored.

All descriptions and illustrations provided in this document have been carefully prepared but we reserve the right to make changes and improvements in our products which may affect the accuracy of the information contained in this leaflet. All goods are sold subject to our standard Conditions of Sale which are available on request.

Aug 2018

Customer support

Monday - Friday

8am - 5pm

Tel 0345 070 1057

Fax 0345 070 1059

Email service@baxicommercialdivision.co.uk

Website www.andrewswaterheaters.co.uk

Twitter @AndrewsWH



Andrews. Built to perform.

part of **BAXI**
COMMERCIAL